

PORTABLE SLIT-LAMP

KOWA

SL-17
PORTABLE SLIT LAMP

INSTRUCTION MANUAL



KOWA SL-17

EU



Introduction

Congratulations on your purchase of the KOWA SL-17. This manual provides a description of the operating procedures and important precautions to be observed during its use. Please read this manual carefully to ensure that the instrument can perform to its full capabilities and work safely. After you have finished reading, keep this manual in an easily accessible location for future reference.

Operational considerations for safety

This manual describes important precautions to be observed when you use the instrument to ensure that the instrument is used safely without causing any damage to the human body or property of the purchaser and other persons.

The following designations and pictorial symbols should be fully comprehended before reading the manual.

Meanings of designations



Warning

Improper operation may result in serious injury^{*1} or death.



Caution

Improper operation may result in bodily injury^{*2} or property damage^{*3}.

*1 Serious injury means vision loss, an injury, high- or low-temperature burn, electrical shock, fracture, or poisoning that causes a subsequent complication or requires hospitalization or long-term outpatient treatment.

*2 Bodily injury means an injury, burn, electrical shock and so forth that will not necessitate hospitalization or long-term outpatient treatment.

*3 Damage to property means extensive damage to a house and/or household goods as well as a domestic animal and pet.

Meanings of symbols



Graphical indication of any warning and caution.
What is warned is explicitly and pictorially indicated by a picture or its associated message on or near a pictorial symbol.



Graphical indication of prohibited operation (prohibitive item).
What is prohibited is explicitly and pictorially indicated by a picture or its associated message on or near a pictorial symbol.





Graphical indication of any mandatory action (obligatory item).
What must always be done is explicitly and pictorially indicated by a picture or its associated message on or near a pictorial symbol.

Disclaimer



Kowa is not responsible for:

- Any damage caused by fire, earthquake, third party's action, abuse or use under abnormal conditions, or any accident caused by a user's intentional or unintentional error.
- Any damage resulting from use of the product or its malfunction (e.g. operating loss, shutdown, change/loss of stored data and so forth).
- Any damage resulting from disregarding what is described in this manual.
- Any damage resulting from malfunctioning caused by a combination of connected devices.

⚠ Warning



 Prohibitory	Do not place a container or cup containing liquid near the instrument. Spilled liquid entering into the instrument may cause electrical shock. If liquid should be spilled into the instrument, Contact Kowa or your authorized Kowa dealer for inspection.
	Do not touch the battery box with a wet hand. Otherwise, it may cause electrical shock.
	The air vent shown in the illustration must not be obstructed. Obstructing the air vent may increase the internal temperature, causing fire, instrument damage, or instrument malfunction. Do not insert any metal object into the air vent or opening of the instrument. Otherwise, it may cause fire, electrical shock, or instrument malfunction.
	Do not short-circuit the terminals of the instrument or battery box. Otherwise, it may cause fire or electrical shock.
 Disassembly prohibited	Do not disassemble, modify or repair the instrument by yourself. Otherwise, it may cause fire, electrical shock, bodily injury, or instrument malfunction. Refer all servicing to Kowa or your authorized Kowa dealer. The instrument disassembled, modified or repaired by anyone other than a Kowa designated repair facility will void the warranty.
 Obligatory	If there is any abnormal odor, sound, heat, or smoke when turning the lamp switch on, turn the lamp switch off immediately. Continued use may cause to fire or instrument malfunction. Contact Kowa or your authorized Kowa dealer for inspection.
	Use a battery box specified by Kowa. Use of battery boxes not specified by Kowa may cause to fire or instrument malfunction.

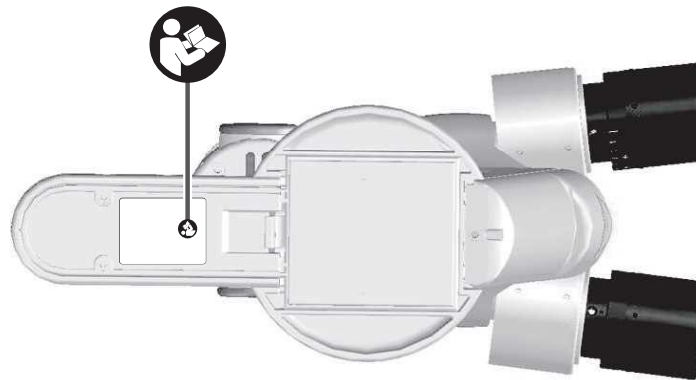
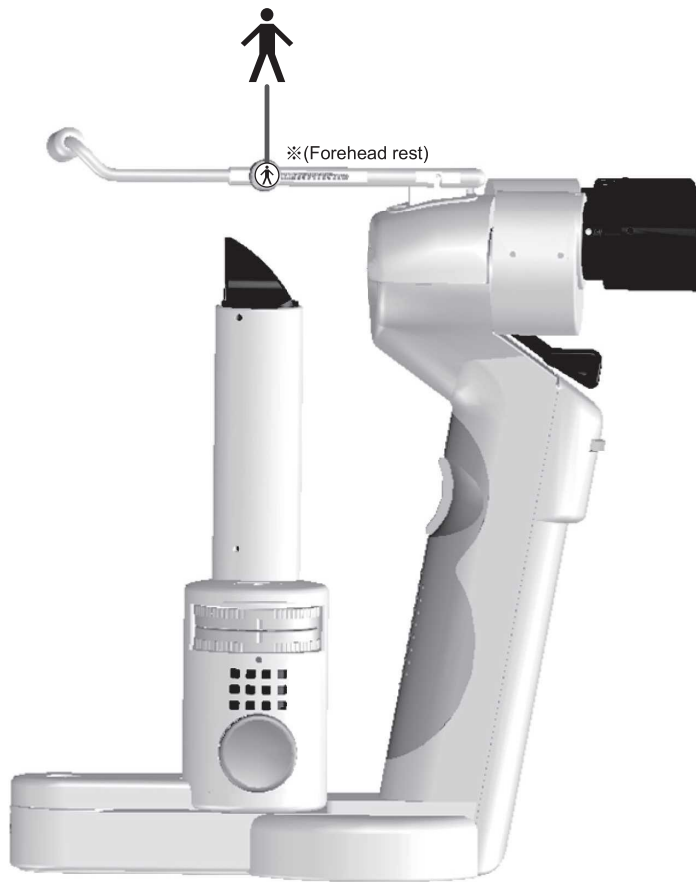

⚠ Caution

 Prohibitory	Do not use lithium ion batteries or lithium batteries. Damage from the use of these batteries may cause to fire, injury or instrument malfunction. For more information, see "Precautions for batteries and charger" described in Operating precautions.
	Do not wipe the exterior with benzene, thinner, or ethanol. It may lead to discoloration or deterioration.
	Do not allow terminals to come into contact with water. Failure to do so may lead to failure. If the terminals are soiled, wipe with a soft cloth containing no water.
	Do not place the hands between the revolving arm and the coupled arm. It may lead to injury if the hand is caught when the arms move.
	Do not put your fingers between the prism boxes. The hand may be caught and lead to injury when adjusting interpupillary distance.
	Do not install the instrument at unstable location such as on a shaky base or a tilting surface. Otherwise, the instrument may drop or fall over, causing a bodily injury.
	Use in locations free from humidity, dust, soot and steam. Failure to do so may lead to fire or electric shock.
 Obligatory	Remove and store the batteries if the main unit will not be used for extended periods. Failure to do so may result in dead batteries.
	Attach the battery box properly. Failure to do so may lead to DAMAGE AND injury due to dropping of the battery box.
	Insert batteries in the battery box properly. Failure to do so may lead to failure.
	When using or carrying the instrument, hold it firmly. Dropping the instrument may lead to injury.
	When operating the forehead rest, tightly fasten the set screws beforehand to keep from slackening during operation. Otherwise, the forehead rest may accidentally jerk forward and cause injury.
	When using the forehead rest set screw, firmly tighten the set screw so that it will not come loose. If the forehead rest suddenly comes out, it may lead to injury.
	When using the camera connection adapter, tighten the fitting screw and set screw firmly so that it does not come loose and result in injury or property damage. It may lead to injury if it comes loose from the instrument.
When placing the main unit on its stand, hold it by the grip and insert it horizontally into the stand. If held anywhere other than the grip, the hand may be caught, leading to injury.	

Meanings of symbols



	<p>Symbol for “Follow instruction manual for use”</p>
	<p>Symbol for “Type B applied part”</p>

	<p>Symbol for “Authorised Representative in the European Community”</p>
	<p>Symbol for “Manufacturer”</p>

*Forehead rest is optional accessory.

Operating precautions

1. Operating environment

- 1) Avoid high temperature and humidity, direct sunlight and dust when transporting, installing and storing the instrument. Strictly observe the following environmental conditions.

	Operational	Transport and storage
Environmental temperature	10 to 35 °C	- 15 to + 55 °C
Relative humidity	30 to 90 %	10 to 95 %
Atmospheric pressure	800 to 1,060 hPa	700 to 1,060 hPa

- 2) Avoid condensation when using, transporting or storing the instrument.

2. Precautions for electrical systems

- 1) Do not turn the lamp switch ON/OFF repeatedly. Wait for an interval of at least 1 second when switching ON/OFF.
- 2) Kowa is not liable for malfunction and/or damages resulting from maintenance and/or repairs performed by a third party other than an agent authorized by Kowa.
- 3) Kowa is not liable for malfunction and/or damages resulting from maintenance and/or repairs using parts other than repair parts specified by Kowa.

3. Precautions when using this instrument

- 1) Disinfect all parts accessible by the patient with alcohol.
- 2) Handle the instrument carefully and do not subject it to strong impact. Do not operate the instrument after it has been subjected to strong impact, dropping or any other kind of damage.
- 3) Disinfect using alcohol the parts accessible by the patient.
 - Severe damage or deterioration of the exterior
 - Deterioration or leaking of batteries
- 4) Never disassemble or adjust this instrument by yourself as it involves precision parts which require special tools.
- 5) Always cover this instrument with dust cover when not in use in order to protect.
- 6) For running out of batteries, please prepare new batteries.

4. Disposal precautions

When disposing of this instrument, applicable federal, state, and local regulations must be observed. Ensure that disposal is handled by a licensed industrial waste disposal contractor in accordance with the applicable regulations and ordinances.

Precautions for batteries and charger

- The Kowa SL-17 uses 4 pcs of AAA batteries [Alkaline or Ni-MH]. Handle batteries in accordance with the following items.
 - For dry cell batteries (primary batteries), use Alkaline battery.
 - For rechargeable batteries (secondary batteries), use rechargeable Nickel Metal Hydride battery.
 - Do not use new and old batteries together, or batteries of different brands or types together.
 - Make sure that batteries are inserted in the instrument in correct polarity positions. Batteries inserted in the wrong direction may lead to failure.



Prohibitory

Do not use lithium ion batteries or lithium batteries. Damage from the use of these batteries may lead to fire, injury or instrument malfunction.

- Use of the following batteries is recommended as for rechargeable Nickel Metal Hydride batteries.
TOSHIBA CORPORATION rechargeable Nickel Metal Hydride battery series
If you wish to purchase the recommended product, contact Kowa or your authorized Kowa dealer.
- When using rechargeable batteries, always use the charger recommended by the battery manufacturer. Read respective instruction manuals for precautions on batteries and chargers.
- Always take the following precautions to avoid a serious injury, burn or fire caused by heat build-up, ignition, explosion and fluid leakage.
 - If heat build-up occurs, immediately move away from the instrument. Leaked fluid or the instrument may catch fire and explode.
 - If battery fluid gets into the eyes, rinse it off with clean water and see a doctor at once.
 - If your body or clothes are contaminated with battery fluid, wash it out.



Obligatory

Remove batteries when the batteries have run out, or when the instrument will not be used for extended periods (three months or longer). Leaving the batteries inside the instrument for extended periods may cause leakage of battery fluid. In addition, when batteries have run out, remove all the batteries inside, and replace with new ones.

Batteries and chargers are not medical equipment. For any trouble with batteries or chargers, contact the respective battery or charger manufacturers.

Precautions: use of medical electrical system

1. Precautions for use of medical electrical system

This instrument constitutes medical electric system by connecting with the following optional accessories.

-Recommended camera (RICOH PENTAX series)

In order to take or save the picture with camera connection adapter of SL-17.

Recommended camera can be installed in patient environment (within a radius of 1.5m around a patient).

When you change the components of this system, and connection after installing the system, you must build secure system according to notes currently written here.

2. Precautions for use of medical electrical system

- 1) Any medical electrical equipment that is connected to this system to compose a medical system must comply with IEC 60601-1.
- 2) Any non-medical electrical equipment that is connected to this system to compose a medical system must comply with safety standards of IEC or ISO provisions applicable to such non-medical electrical equipment.
- 3) The system which consists of this instrument and other electrical devices (here in after referred to as "this system") must comply with IEC 60601-1 when may be installed and used all within a limited patient environment
- 4) This system must comply with safety standards of IEC or ISO provisions when may be installed and used outside patient environment.
- 5) Make sure that the instrument is turned OFF when connecting other device to the system.
- 6) Do not turn ON the power switch until all devices are completely connected.
- 7) Do not place or install the devices and the system components on the unstable or inclined table.

3. Daily maintenance and cleaning

System components

- Wipe the soiled outer surface with firmly squeezed dampened soft cloth. Use mild detergent to remove excessive soils. Do not use chemicals or solvents such as thinner or benzene. (As the monitor screen cover easily gets scratched, lightly wipe it with soft cloth such as gauze.)
- Refer to the instruction for use provided with each device for details of device maintenance and cleaning.

Operational considerations for a hospital grade electrical instrument (safety and accident prevention)

- 1. Only qualified personnel should operate this instrument.**
- 2. The following items shall be considered when installing the instrument.**
 - 1) Install at a location away from water or accidental splashing.
 - 2) Install at a location which will not be adversely affected by atmospheric pressure, temperature, humidity, ventilation, sunlight, dust, and air containing salt, sulfur and other substances, and the like.
 - 3) Take care to guard against tilt, vibration and strong impacts, for instance, during transportation.
 - 4) Instrument must not be installed at locations where chemicals are stored or gasses are generated.
 - 5) Check the status of the batteries (electrical discharge, polarity, etc.).
- 3. The following items shall be considered before using the instrument.**
 - 1) Make sure that the instrument activates properly after checking switch contact, polarity, dial setting and so forth.
 - 2) Use of other instruments and appliances on the same power outlet is liable to cause errors and incorrect output resulting in incorrect diagnosis or hazards.
 - 3) Before operations, make sure that the battery is sufficiently charged.
- 4. The following items shall be considered when using the instrument.**
 - 1) Make sure to minimize the time required for diagnosis.
 - 2) Always assure that the instrument and patient are in good condition.
 - 3) When an abnormality is found on the instrument, take proper measures, for instance, to stop the operation of the instrument while assuring the patient's safety.
 - 4) Do not allow the patient to touch any part of the instrument except for the forehead rest.
- 5. The following items shall be considered after using the instrument.**
 - 1) The following shall be considered regarding storage location.
 - (i) Store at a location away from water or accidental splashing.
 - (ii) Store at a location which will not be adversely affected by atmospheric pressure, temperature, humidity, ventilation, sunlight, dust, air containing salt, sulfur and other substances, and the like.
 - (iii) Take care to guard against tilt, vibration and strong impacts, for instance, during transportation.
 - (iv) Instrument must not be stored at locations where chemicals are stored or gasses are generated.
 - 2) Clean and rearrange accessories, and the like.
 - 3) The instrument must be cleaned after using so that there will be no problem when using it again.
- 6. In case of a problem or malfunction, do not attempt to repair the instrument by yourself. Appropriately label the instrument as "out of order" and contact a qualified technician for repair.**
- 7. Instrument shall not be modified.**
- 8. Maintenance**
 - 1) Periodically check the instrument and its components for any abnormality.
 - 2) When using the instrument that has not been used for a while, it must be checked beforehand to assure that it is in normal condition and operates safely.
- 9. Be careful of the possibility that incorrect operation may be caused by strong electromagnetic waves.**

This instrument is examined based on IEC 60601-1-2.

The purpose of this standard is to keep safety against the dangerous obstacle in typical medical facilities.

In case this instrument is influenced by other instrument, or it affects other instrument or there is such fear, relocate this instrument and other apparatus or extend the distance between those instruments.

If you have any questions, please consult Kowa or your authorized Kowa dealer.

Components and supplies

Main unit and accessories

Main unit : 1



Dry cell batteries : 4 (AAA batteries [Alkaline])



Dust cover : 1

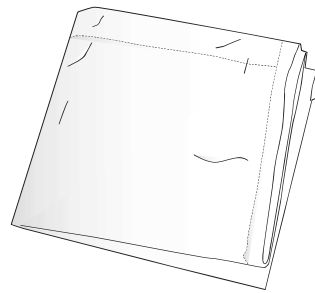

Stand : 1



Instruction manual : 1



Optional accessories

Forehead rest : 1

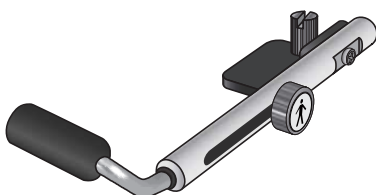

Camera connection adapter : 1



Contents

Introduction.....	I
Meanings of symbols.....	III
Operating precautions	IV
Precautions: use of medical electrical system	V
Operational considerations for a hospital grade electrical instrument (safety and accident prevention)	VI
Components and supplies.....	VII
Contents	VIII
1 Instrument description	1
1.1 Intended use.....	1
1.2 Overview.....	1
1.3 Features	1
1.4 Name and function of each part.....	2
2 Preparation.....	3
2.1 Inserting batteries in the main unit	3
2.2 Adjusting interpupillary distance and diopter	3
3 How to use	5
3.1 How to operate the slit lamp.....	5
3.2 How to operate other functions.....	5
3.3 How to use the stand.....	6
3.4 How to fit optional item.....	7
4 Maintenance and inspection.....	9
4.1 Regular maintenance	9
4.2 Daily inspection	9
4.3 Replacing batteries (when the light intensity control dial blinks)	10
4.4 Cleaning	11
5 Troubleshooting.....	12
6 Specifications	13
7 Light Hazard	14
8 Electromagnetic compatibility.....	15

1.1 Intended use

KOWA SL-17 is intended for use in eye examination of the anterior eye segment, from the cornea epithelium to the posterior capsule. It is used to aid in the diagnosis of diseases or trauma which affect the structural properties of the anterior eye segment.

1.2 Overview

The KOWA SL-17 is a portable slit-lamp run by 4 pcs of AAA batteries [Alkaline or Ni-MH]. The instrument includes the main unit (slit-lamp), one set of 4 dry cell batteries, stand, and dust cover.

1.3 Features

- Lamp switch is turned on when the operator simply grasps the slit-lamp.
- Quick, one-touch selection of 10x or 16x magnification.
- Blue filter for observing fluorescent straining.
- Light intensity control dial which enables flexible control of the brightness of the lamp.
- Light intensity control dial which notifies the operator of low battery level.
- Bright white pulsed (800 Hz) LED is used as the light source.
- Energy efficient LED enables long hours of continuous lighting (130 minutes [new Alkaline batteries]).
- Compatible with electronic images when used with the optional camera connection adapter (C mount: 1/2 inch or 1/3 inch).
- Can also be used as an indirect ophthalmoscope.

1.4 Name and function of each part

Main unit (slit-lamp)

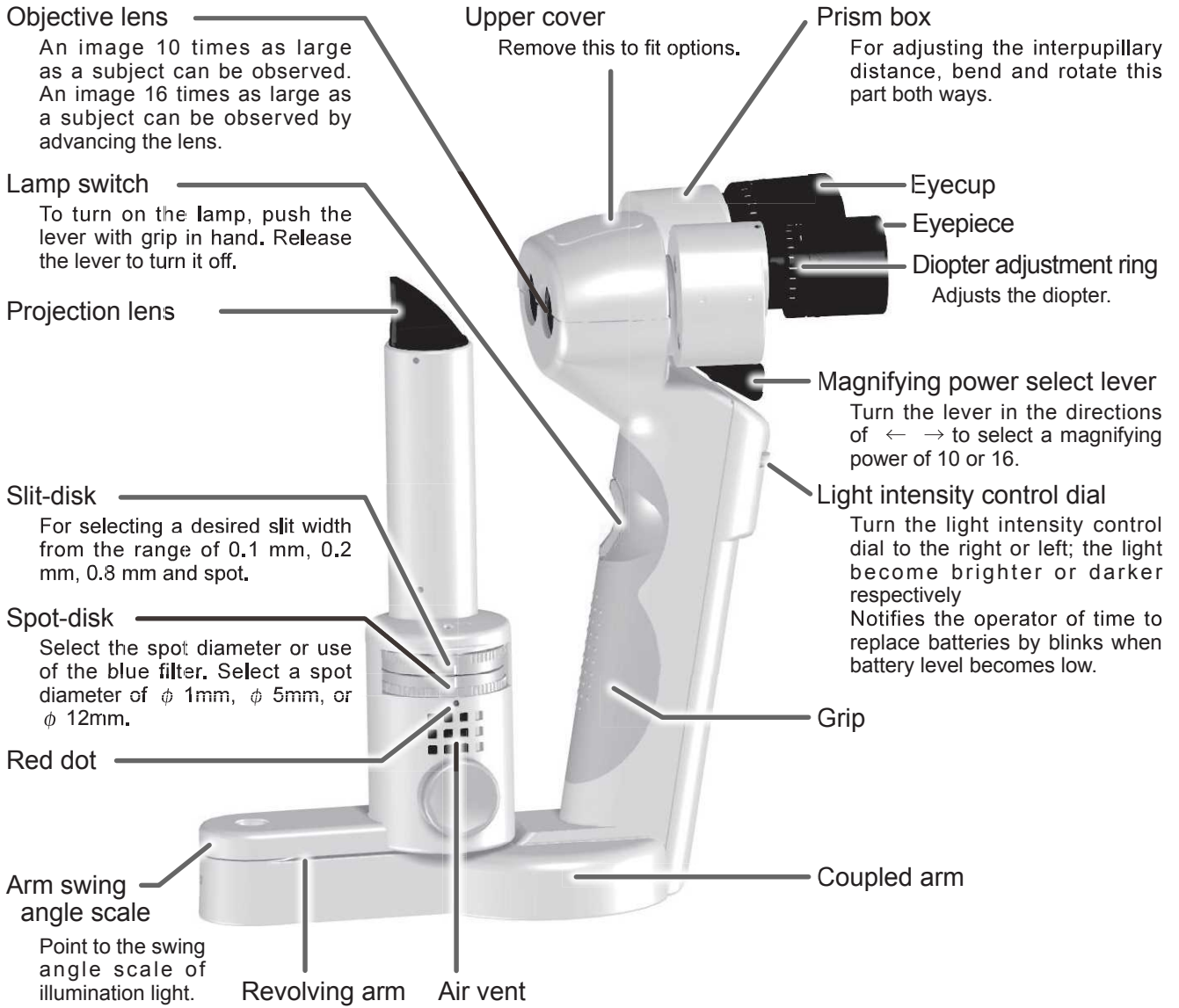

Bottom view

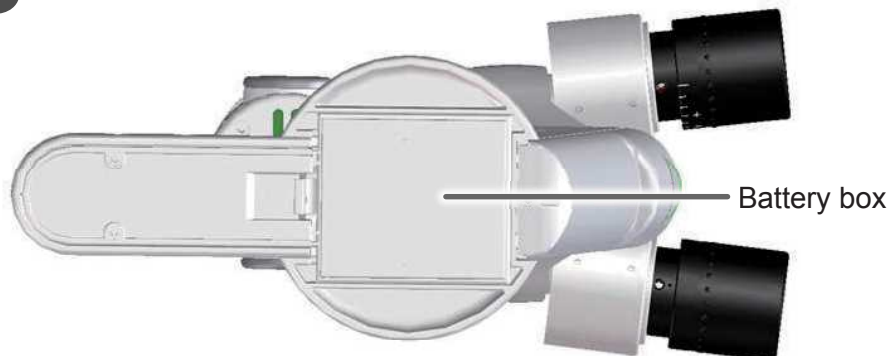

2.1 Inserting batteries in the main unit

Remove the battery box from the main unit.

- ① While pressing down the tab of the battery box, pull the battery box out to open it.

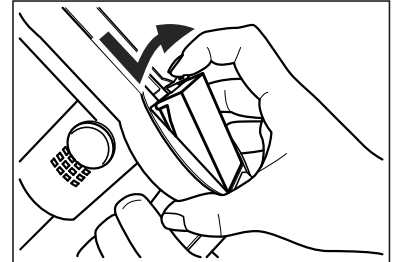

- ② Firmly insert batteries in correct polarity positions written on the battery box. The method of inserting batteries is to insert from the + terminal and push on the - terminal.

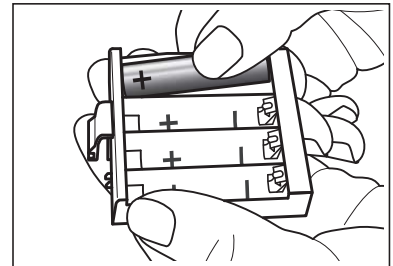

- ③ Return the battery box to the main unit. Insert the battery box until the tab makes a click sound. The battery box will drop if the instrument is used without the battery box firmly in place, and may cause damage or injury.
- ④ Push the lamp switch to see if the lamp and the light intensity control dial light.
 - * While pushing the lamp switch, the light intensity control dial lights green. When the light intensity control dial blinks, power supply voltage is falling. Please replace batteries according to "4.3 When the light intensity control dial blinks (replacing batteries)".

2.2 Adjusting interpupillary distance and diopter

Before using the instrument, adjust the interpupillary distance and diopter.

- ① Adjusting interpupillary distance

To obtain an adequate field of view through the eyepieces, adjust the interpupillary distance width by rotating both prism boxes in opposite directions.

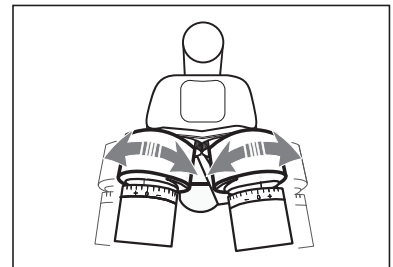

- ② Adjusting diopter

With the diopter adjustment ring turned to its full plus (+) range, look into the eyepiece with each eye while slowly turning it to its minus (-) direction. When the reticle comes into clear sight, stop turning. A person wearing eyeglasses may use the eyepiece with the eyecup folded forward.

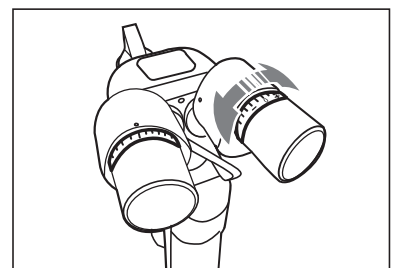

3.1 How to operate the slit lamp

- ① Use the grip to hold the main unit securely in your hand.
- ② Place the thumb of your other hand on the side of the upper cover of the main unit, and put other fingers on the forehead of the patient.
- ③ Stabilize slit width indication by adjusting the distance between the examined eye and the objective lens, depending on how wide the opening is between the thumb and the fingers when put on the patient's forehead.

*(If optional forehead rest is used, it is much easier to fix the main unit.)

- ④ Please push the lamp switch and irradiate the light for various observation of eye.

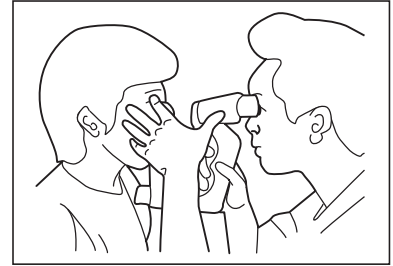

3.2 How to operate other functions

- Changing observation magnification
Turn the magnifying power select lever to the left as indicated by arrow-head to select a magnifying power of 16.
Turn it to the right to select a magnifying power of 10.
- Changing slit-width
Turn the slit-disk as far as it is set at one of the 4 click stops, which will cover 3 types of slit widths (0.1 mm, 0.2 mm and 0.8 mm). The point marking "○" indicates "spot". Slit-width will be indicated at a point marking a red dot.
- Changing the spot light size/inserting the blue filter spot light can be switched among ϕ 1 mm, ϕ 5 mm, and ϕ 12 mm by rotating the spot-disk. In addition, when the disk is set to "B", then the blue filter is inserted. Depending on a combination of the slit-disk and the spot-disk, the image of light becomes the ellipse shape.
- Light adjustment
Turn the light intensity control dial to the right or left; the light becomes brighter or darker, respectively.

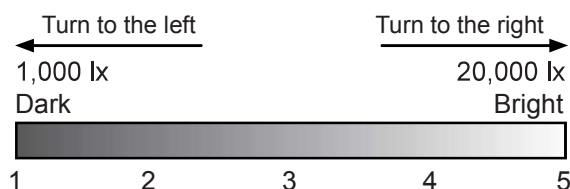
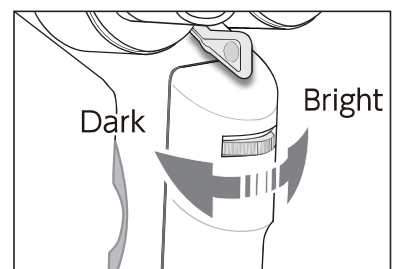
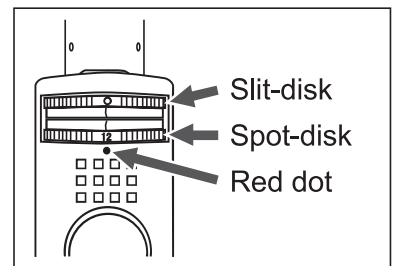
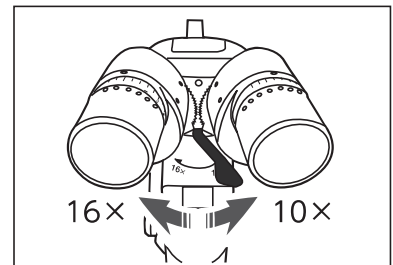

3.3 How to use the stand

By using the stand, the main unit can be stored in a stable manner.

- ① Install the stand at a horizontal and flat location.
- ② Hold the main unit by the grip and insert it horizontally into the stand.

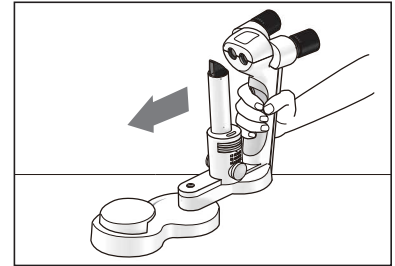

Caution



Prohibitory

Do not install the main unit and stand at a unstable location such as on a shaky base or a tilting surface. Otherwise, the main unit and the stand may drop or fall over, causing a bodily injury.



Obligatory

When placing the main unit in its stand, hold it by the grip and insert it horizontally into the stand. If held anywhere other than the grip, the hand may be caught, leading to injury.

3 How to use

3.4 How to fit optional item

3.4.1 Forehead rest

- ① Open the upper cover located on the top of the main unit with a toothpick or similar device.

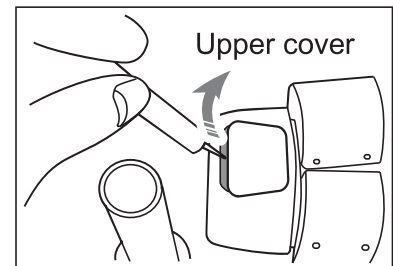

- ② Tighten screw with an object such as a coin to fit the forehead rest.

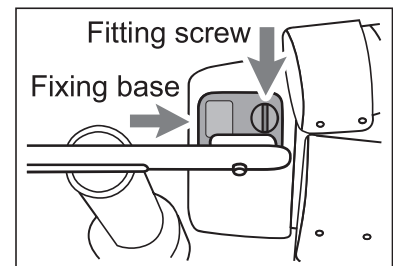

- ③ Rotating and loosening the set screw spring the forehead rest back and forth.

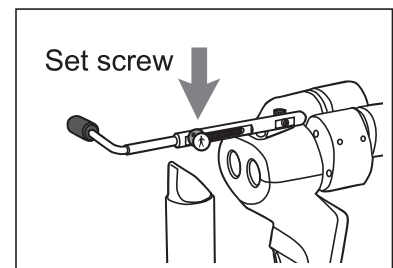

Caution



Obligatory

When operating the forehead rest, tightly fasten the set screws beforehand to keep from slackening during operation. Otherwise, the forehead rest may accidentally jerk forward and cause injury.

When using the forehead rest set screw, firmly tighten the set screw so that it will not come loose. If the forehead rest suddenly comes out, it may lead to injury.

3.4.2 Camera connection adapter

- ① Open the upper cover located on the top of the main unit with a toothpick or similar device.
 - ② Loosen the locking screw attached to right and left both sides of the camera connection adapter and remove the fixing base.
 - ③ Fit the fixing base in the position of the upper cover and tighten it in the fitting screw attached to the camera connection adapter.
 - ④ Select magnifying power of 10, and confirm that objective lens does not project.
Tighten the locking screw the camera connection adapter with the fixing base.
- * When attaching the camera connection adapter, the observation magnification select only a magnifying power of 10. Do not select a magnifying power of 16.

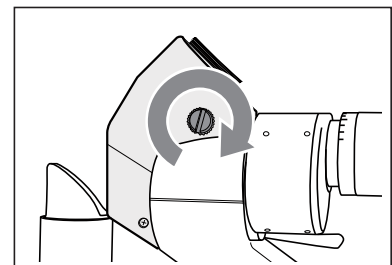
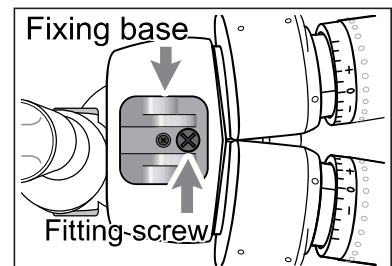
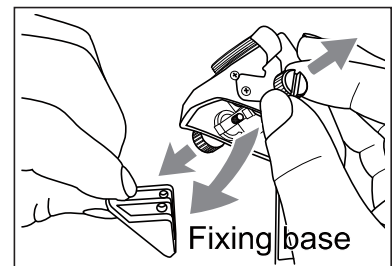
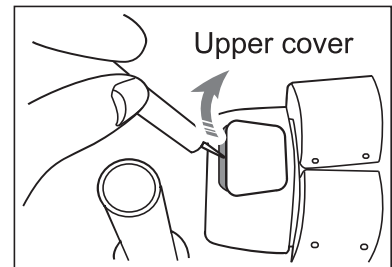

⚠ Caution



Obligatory

When using the camera connection adapter, tighten the fitting screw and locking screw firmly so that it does not come loose and result in injury or property damage. It may lead to injury if it comes loose from the instrument.

This instrument is a precision instrument and daily maintenance and inspection may affect the imaging results. Please read this section carefully in order to use this instrument correctly and safely.

4.1 Regular maintenance

- Make sure to place the dust cover on the instrument after use.
- Make sure the projection lens, objective lens and lens of eyepieces are not contaminated with dust, debris, finger prints, and/or tear fluid.
- Clean the instrument with a soft piece of cloth. For obstinate dirt, apply diluted detergent.
- Clean the terminal part of the main unit and the battery box and batteries with a soft piece of cloth dampened with water. For obstinate dirt, apply diluted detergent.
- If the instrument will be not used for extended periods, remove the battery box from the main unit and remove batteries from the battery box.
- For maintenance of the charger and battery, follow the respective instruction manuals.

4.2 Daily inspection

Inspect this instrument in accordance with “KOWA SL-17 daily inspection table” below.

KOWA SL-17 daily inspection table			
Inspection item		Procedure	Acceptability criteria
Main unit (slit-lamp)	Enclosure	Visually verify that there is no problem.	There is no deformation.
	Projection lens Objective lens Lens of eyepieces	Visually verify that there are no flaws or contaminants on the lenses.	There are no flaws or contaminants.
	Lamp switch	Operate the switch to see if it works normally.	When pushed, the lamp and the light intensity control dial should light.
	Slit-disk Spot-disk	Move the disk to see that it moves without any problems and has clicks.	The disk should move smoothly. There should be clicks.
	Magnifying power select lever	Move the lever to see that it moves without any problems.	The lever should move smoothly.
	Light intensity control dial	Move the dial to see that it moves without any problems.	The dial should move smoothly.
	Rating label	Visually check that the label is securely installed and that all indications are clearly visible.	The label must be securely installed. All indications must be clearly visible.
	Terminal part	Visually check if the terminal parts are soiled.	They should not be soiled or black.
Battery box	Enclosure	Visually verify that there is no problem.	There is no deformation.
	Terminal part	Visually check if the terminal parts are soiled.	They should not be soiled or black.
Stand	Enclosure	Visually verify that there is no problem.	There is no deformation.

4.3 Replacing batteries (when the light intensity control dial blinks)

When the light intensity control dial blinks, power supply voltage is falling. Please replace with new batteries.

Remove the battery box from the main unit.

- ① While pushing down the tab of the battery box, pull the battery box out to remove it.
- ② Remove batteries by pressing the (+) part shown in the right picture.
- ③ Insert new batteries.
(See "2.1 Inserting batteries in the main unit" for how to insert batteries.)
- ④ When rechargeable batteries run out, charge them with the charger recommended by the manufacturer of the battery.
(See the instruction manual of the charger for how to charge the battery.)

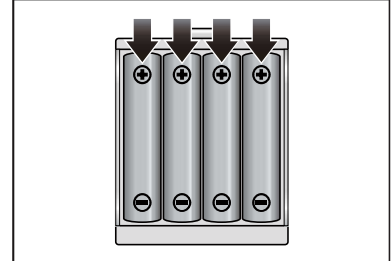

Dispose of dry cell batteries and rechargeable batteries in accordance with the designated disposal method.

Battery types and continuous lighting minutes

Type of battery	Rough guide for continuous lighting minutes at maximum intensity
Rechargeable battery	140 minutes *When used the AAA batteries (Ni-MH) of 750 mAh, and the room temperature is 25 °C
Dry cell battery	130 minutes *By our company's test result, when used the AAA batteries (Alkaline) of TOSHIBA CORPORATION

IMPORTANT

- Keep in mind that the continuous lighting time will vary depending on a temperature or frequency of charging. In general, the greater frequency of use shortens the continuous lighting time.
- If the batteries should be left unused, the performance will gradually decrease even if it will not be used at all. If you have extra batteries, please alternate them regularly to maintain efficient performance.

4 Maintenance and inspection

4.4 Cleaning

4.4.1 Cleaning and disinfecting the forehead rest

Make sure to wipe the forehead rest with rubbing alcohol as soon as a patient completes the examination.

4.4.2 Cleaning the exterior

When the exterior of this instrument is dirty, follow the steps below to clean it.

- ① Turn OFF the lamp switch.
- ② Wipe the surface with a firmly squeezed, dampened soft cloth.
- ③ Wipe off the obstinate dirt with soft cloth, after dampening it in water or lukewarm water with diluted small amount of neutral detergent and firmly squeezing it.

Caution



Prohibitory

- Do not wipe the exterior with benzene, thinner, or ethanol. It may lead to discoloration or deterioration.
- Do not allow terminals to come into contact with water. Failure to do so may lead to failure. If the terminals are soiled, wipe with a soft cloth containing no water.

4.4.3 Cleaning the projection lens, objective lens and lens of eyepieces

When the projection lens, objective lens and lens of eyepieces become soiled, follow the steps below to clean it.

- ① Blow off debris or dust on the lens surfaces using a blower.
- ② When it cannot be cleaned by step ①, moisten a clean gauze pad or sheets of lens cleaning paper with cleaning solution made from ethyl alcohol and ether (1:1) and lightly wipe whole surface of the lens starting from its center in a circular motion. Repeat this step several times.
- ③ If any soil is left after step ②, gently wipe off the soiled area with a cotton swab soaked with a small amount of water. After you have done this, repeat step ②.
- ④ If any soil cannot be removed by steps ① through ③, contact Kowa or your authorized Kowa dealer.



Use a new gauze pad, new cleaning paper, or a new cotton swab every time you wipe.

IMPORTANT

- Wiping the projection lens, objective lens, or lens of eyepiece without removing dust and debris beforehand may scratch the lens surface.
- Do not use chamois leather, silicon cloth, etc.
- Carefully store and handle the flammable and combustible cleaning solution made from ethyl alcohol and ether.
- Do not use any other agent or cloth.

When a problem occurs, check the items shown below first. Look for the problem from those shown in the following list and apply the applicable remedy. If the described applicable remedy does not eliminate the problem or you encounter a problem that is not listed, contact Kowa or your authorized Kowa dealer.

This section describes troubleshooting procedures to solve problems you may encounter.

Abnormal performance of the instrument		
Problem	What to check · State of instrument	Applicable remedy
The lamp does not light when the lamp switch is pushed.	Is the battery box in place?	Mount the battery box.
	Is the light intensity control dial blinking?	If you use rechargeable batteries, do not insert the rechargeable batteries which are not being charged enough. Replace new batteries.
	Battery is coming out.	Firmly insert batteries in correct polarity positions.
	Are the batteries being inserted in opposite of the positive and negative?	Firmly insert batteries in correct polarity positions written on the battery box.
	Spot-disk is wrongly set at a point away from the red dot.	Set the spot-disk at the red dot.
	Slit-disk is wrongly set at a point away from the red dot.	Set the slit-disk at the red dot.
	Does the light intensity control dial rotate?	While pressing the lamp switch, rotate the dial to the right to increase light intensity.
The lamp goes off quickly. (battery consumption is fast)	Are the batteries charged?	When using rechargeable batteries, charge the batteries.
	Are the batteries depleted?	Replace with new batteries. Rechargeable batteries gradually deplete after repeating charge and discharge.
The slit tilts.	Slit-disk is wrongly set at a point away from the red dot.	Set the slit-disk and spot-disk at the red dot.
Part of the illumination light or slit is obscured.	Slit-disk or spot-disk is wrongly set at a point away from the red dot.	Set the slit-disk at the red dot.
Out of focus.	Diopter is wrongly set at a point away from a desired value.	Adjust to a desired diopter.

Microscope

Type of microscope	Binocular-stereoscopic-orthoscopic microscope
Angle of convergence	13°
Total magnification	10, 16X
Objective lens' working distance	80 mm (when a magnifying power of 16 is selected) 100 mm (when a magnifying power of 10 is selected)
Practical field of view	Ø 10 mm (when a magnifying power of 16 is selected) Ø 15 mm (when a magnifying power of 10 is selected)
Reticles	Built in both eyepieces
Variable power type	2-magnifying power selectable / moving objective lens type
Interpupillary distance adjustment range	50 to 72 mm
Diopter adjustment range	- 8 to + 5D

Slit-projector

Light source	White LED
Slit section	Turret
Slit width	0.1 mm, 0.2 mm, 0.8 mm
Spot	Ø 1 mm, Ø 5 mm, Ø 12 mm and shapes of ellipse
Slit length	12 mm
Light intensity adjusting	Continuously-variable (Limit is until 20,000 lux)
Slit's illuminating angle	± 60° with respect to its horizontal outer periphery
Filter	Built in blue filter
Continuous lamp operating time	130 minutes [new Alkaline batteries] (See "4.3")

Electrical ratings

Input voltage	DC 4.8 to 6.4V (4 pcs of AAA batteries [Alkaline or Ni-MH])
Power consumption	3.6 to 4.5 VA

Main unit

Dimensions / Weight	220 (W)×95 (D)×220 (H) mm / 745 g (No batteries)
Expected service life	8 years

Compliance standard

- EN 60601-1:2006
- EN 60601-1-2:2007

Classification of equipment based on IEC 60601-1

- According to the type of protection against electric shock (Internal electrical power source device)
- According to the degree of protection against electric shock (Type B applied part) ... Forehead rest
- According to the type of protection against ingress of water as detailed in the current edition of IEC 60529. (IPX0)
- According to the degree of safety of application in the presence of a flammable anaesthetic mixture with air or with oxygen or nitrous oxide. (Equipment not suitable for use in the presence of a flammable anesthetic mixture with air or with oxygen or nitrous oxide)
- According to the mode of operation. (Continuous operation)

Complied EC Directive

Medical Device Directive 93/42EEC : **CE**
WEEE Directive 2002/96/EC

KOWA SL-17 is determined as a Group 2 instrument based on EN ISO 15004-2:2007.
Please become aware of the information below:

"Caution - Light emitted from the instrument is potentially hazardous. The longer the exposure time, the higher the risk of damage to the eyes. When operating the instrument at the maximum intensity, irradiating the light more than 193 seconds will exceed the safety guideline."

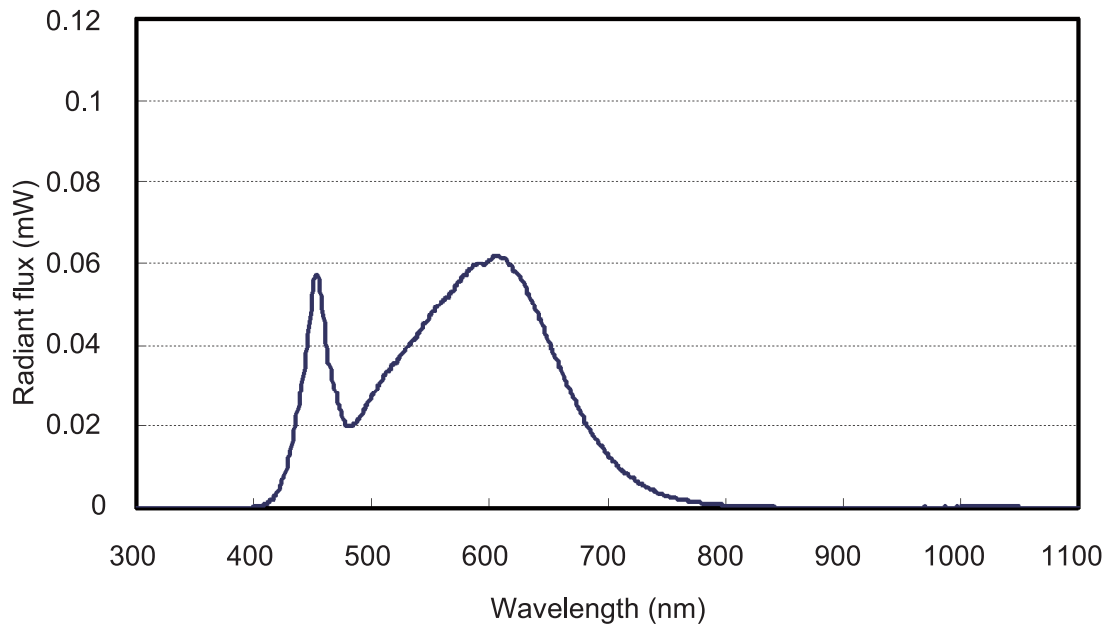

This instrument is a electrical medical instrument. Electrical medical instruments require special attention to the electromagnetic compatibility (EMC). The following section describes the EMC and precautions regarding this instrument. When installing or using this instrument, read the description carefully and follow the directions described.

(The EMC of this instrument was tested based on IEC 60601-1-2.)

1. Please note that portable- or mobile-type radio frequency communication devices (RF communications instrument) may adversely affect this instrument resulting in malfunctioning.
2. The electromagnetic compatibility (EMC) of this instrument was tested with the accessories shown below. Since using an option or accessory other than those specified may cause malfunctioning of this instrument due to interferences of external device or cause malfunctioning of external device, use only the options or accessories specified for this instrument.
 - Camera connection adapter
 - Recommended camera (RICOH PENTAX)
3. This instrument is not designed to be used adjacent to a external instrument or placed on top of another. Therefore, do not apply such use. Nevertheless, if such use is inevitable, it is necessary to monitor constantly to ensure the instrument is functioning normally after such use has been adopted.
4. The operations which shows this instrument in the following table are verified to determine electromagnetic compatibility (EMC) of this instrument.

Function	Basic operations
Functions concerning operation of the instrument	Switching ON/OFF the lamp

Compliance verification and guidance

Guidance and manufacturer's declaration – electromagnetic emissions		
The KOWA SL-17 is intended for use in the electromagnetic environment specified below. The customer or the user of the KOWA SL-17 should assure that it is used in such an environment.		
Emissions test	Compliance	Electromagnetic environment - guidance
RF emissions CISPR 11	Group 1	The KOWA SL-17 uses RF energy only for its internal function. Therefore, its RF emissions are very low and are not likely to cause any interference in nearby electronic equipment.
RF emissions CISPR 11	Class B	The KOWA SL-17 is suitable for use in all establishments, including domestic establishments and those directly connected to the public lowvoltage power supply network that supplies buildings used for domestic purposes.
Harmonic emissions IEC 61000-3-2	Not applicable The equipment is battery powered only.	
Voltage fluctuations / flicker emissions IEC 61000-3-3	Not applicable The equipment is battery powered only.	

Guidance and manufacturer's declaration – electromagnetic immunity			
The KOWA SL-17 is intended for use in the electromagnetic environment specified below. The customer or the user of the KOWA SL-17 should assure that it is used in such an environment.			
Immunity test	EN/IEC 60601 test level	Compliance level	Electromagnetic environment – guidance
Electrostatic discharge (ESD) IEC 61000-4-2	±6 kV contact ±8 kV air	±6 kV contact ±8 kV air	Floors should be wood, concrete or ceramic tile. If floors are covered with synthetic material, the relative humidity should be at least 30 %.
Electrical fast transient/burst IEC 61000-4-4	±2 kV for power supply lines ±1 kV for input/output lines	Not applicable Not applicable	This test is not applicable since the equipment is battery powered only and has no input/output line to be tested.
Surge IEC 61000-4-5	± 1 kV line(s) to line(s) ± 2 kV line(s) to earth	Not applicable Not applicable	This test is not applicable since the equipment is battery powered only.
Voltage dips, short interruptions and voltage variations on power supply input lines IEC 61000-4-11	< 5 % U^T (> 95 % dip in U^T) for 0,5 cycle	Not applicable	This test is not applicable since the equipment is battery powered only.
	40 % U^T (60 % dip in U^T) for 5 cycles	Not applicable	
	70 % U^T (30 % dip in U^T) for 25 cycles	Not applicable	
	< 5 % U^T (> 95 % dip in U^T) for 5 s	Not applicable	
Power frequency (50/60 Hz) magnetic field IEC 61000-4-8	3 A/m	3 A/m	Power frequency magnetic fields should be at levels characteristic of a typical location in a typical commercial or hospital environment.
NOTE U^T is the a.c. mains voltage prior to application of the test level.			

8 Electromagnetic compatibility

Guidance and manufacturer's declaration – electromagnetic immunity			
The KOWA SL-17 is intended for use in the electromagnetic environment specified below. The customer or the user of the KOWA SL-17 should assure that it is used in such an environment.			
Immunity test	EN/IEC 60601 test level	Compliance level	Electromagnetic environment – guidance
Conducted RF IEC 61000-4-6	3 Vrms 150 kHz to 80 MHz	Not applicable	Portable and mobile RF communications equipment should be used no closer to any part of the KOWA SL-17, including cables, than the recommended separation distance calculated from the equation applicable to the frequency of the transmitter. Recommended separation distance This test is not applicable since the equipment has no power or input/output line.
Radiated RF IEC 61000-4-3	3 V/m 80 MHz to 2.5 GHz	3 V/m	$d=1.2\sqrt{P}$ 80 MHz to 800 MHz $d=2.3\sqrt{P}$ 800 MHz to 2.5 GHz where P is the maximum output power rating of the transmitter in watts (W) according to the transmitter manufacturer and d is the recommended separation distance in meters (m). Field strengths from fixed RF transmitters, as determined by an electromagnetic site survey, ^a should be less than the compliance level in each frequency range. ^b Interference may occur in the vicinity of equipment marked with the following symbol: 
NOTE 1 At 80 MHz and 800 MHz, the higher frequency range applies.			
NOTE 2 These guidelines may not apply in all situations. Electromagnetic propagation is affected by absorption and reflection from structures, objects and people.			
^a Field strengths from fixed transmitters, such as base stations for radio (cellular/cordless) telephones and land mobile radios, amateur radio, AM and FM radio broadcast and TV broadcast cannot be predicted theoretically with accuracy. To assess the electromagnetic environment due to fixed RF transmitters, an electromagnetic site survey should be considered. If the measured field strength in the location in which the KOWA SL-17 is used exceeds the applicable RF compliance level above, the KOWA SL-17 should be observed to verify normal operation. If abnormal performance is observed, additional measures may be necessary, such as reorienting or relocating the KOWA SL-17.			
^b Over the frequency range 150 kHz to 80 MHz, field strengths should be less than 3 V/m.			

Recommended separation distances between portable and mobile RF communications equipment and the KOWA SL-17			
The KOWA SL-17 is intended for use in an electromagnetic environment in which radiated RF disturbances are controlled. The customer or the user of the KOWA SL-17 can help prevent electromagnetic interference by maintaining a minimum distance between portable and mobile RF communications equipment (transmitters) and the KOWA SL-17 as recommended below, according to the maximum output power of the communications equipment.			
Rated maximum output power of transmitter W	Separation distance according to frequency of transmitter m		
	150 kHz to 80 MHz $d=1.2\sqrt{P}$	80 MHz to 800 MHz $d=1.2\sqrt{P}$	800 MHz to 2.5 GHz $d=2.3\sqrt{P}$
0.01	Not applicable	0.12	0.23
0.1	Not applicable	0.38	0.73
1	Not applicable	1.2	2.3
10	Not applicable	3.8	7.3
100	Not applicable	12	23
For transmitters rated at a maximum output power not listed above, the recommended separation distance d in meters (m) can be estimated using the equation applicable to the frequency of the transmitter, where P is the maximum output power rating of the transmitter in watts (W) according to the transmitter manufacturer.			
NOTE 1 At 80 MHz and 800 MHz, the separation distance for the higher frequency range applies.			
NOTE 2 These guidelines may not apply in all situations. Electromagnetic propagation is affected by absorption and reflection from structures, objects and people.			



Likvidace tohoto výrobku

Likvidace tohoto výrobku musí být podle zákona provedena ekologicky a výrobek je třeba individuálně soustředit na sběrných místech. Při likvidaci tohoto výrobku postupujte podle pokynů na následující webové stránce. Nemůžete-li tuto webovou stránku použít, obraťte se na prodejce.

URL: <http://www.kowa-europe.com/>

Bortskaffelse af dette produkt

Miljørigtig bortskaffelse er angivet ved lov for dette produkt, og det skal bortskaffes særskilt. Bortskaffelse af dette produkt skal foregå i overensstemmelse med proceduren på følgende webside. Hvis du ikke kan finde det på websiden, skal du kontakte din forhandler.

URL: <http://www.kowa-europe.com/>

Procedure voor opruimen van dit product

Dit product dient volgens een wettelijke bepaling op een milieuvriendelijke manier te worden opgeruimd en dient afzonderlijk voor opruimen opgehaald te worden. Ruim dit product op overeenkomstig de procedure door de volgende website te raadplegen.

Als u de website niet kunt raadplegen, contact opnemen met uw dealer.

URL: <http://www.kowa-europe.com/>

Disposal procedure for this product

An environmentally-friendly disposal method is specified by law for this product and it must be collected individually for disposal. Please discard this product in accordance with the procedure referred to in the following website.

If you cannot access the website, please contact your dealer.

URL: <http://www.kowa-europe.com/>

Toote äraviskamise eeskirjad

Seadusega on ette nähtud keskkonna sõbralik meetod selle toote jaoks ja seda peab väljaviskamise jaoks eraldi korjama. Palun visake see toode ära vastavalt protseduurile mis on kirjeldatud alljärgnevas veebsaidis.

Kui Te ei saa kätte veebsaiti, palun võtke ühendust oma diileriga.

URL: <http://www.kowa-europe.com/>

Tuotteen hävittämistapa

Laki määrittelee, että tämä tuote on hävitettävä ympäristöystävällisellä tavalla ja että se on toimitettava erikseen hävitettäväksi. Hävittäkää tämä tuote seuraavassa sivustossa kuvatulla tavalla.

Jos ette voi käyttää sivustoa, ottakaa yhteys jälleenmyyjään.

URL: <http://www.kowa-europe.com/>

Procédures d'élimination de cet appareil

La loi prescrit comment vous débarrasser de cet appareil dans le respect de l'environnement en recourant à la collecte sélective individuelle. Veuillez vous débarrasser de cet appareil en procédant de la façon indiquée sur le site Web.

Si vous ne pouvez pas consulter le site Web, adressez-vous à votre revendeur.

URL: <http://www.kowa-europe.com/>

Entsorgung des Produkts

Das Gesetz schreibt die umweltverträgliche Entsorgung dieses Produkts vor. Es darf nicht in den normalen Haushaltsmüll gegeben werden. Bitte entsorgen Sie das Produkt entsprechend den Hinweisen auf dieser Website.

Falls Sie diese Website nicht besuchen können, wenden Sie sich bitte an Ihren zuständigen Fachhändler.

URL: <http://www.kowa-europe.com/>

Διαδικασία απόρριψης του παρόντος προϊόντος

Η φιλική προς το περιβάλλον μέθοδος απόρριψης καθορίζεται από το νόμο για το παρόν προϊόν το οποίο πρέπει να συλλέγεται μεμονωμένα για την απόρριψη. Απορρίψτε το παρόν προϊόν σύμφωνα με τη διαδικασία που αναφέρεται στον παρακάτω ιστόχωρο.

Εάν δεν μπορείτε να κάνετε αναφορά τον ιστόχωρο, επικοινωνήστε με τον αντιπρόσωπο.

URL: <http://www.kowa-europe.com/>

Termék-elhelyezési munkafolyamat

Egy – a törvény által előírt - környezetbarát lerakási módszer létezik erre a termékre, melyet egyesével kell összegyűjteni. Kérjük az ezen a honlapon található folyamat alapján selejtezze ki ezt a terméket. Ha nem tudja elérni a honlapot, kérjük keresse fel a termékforgalmazót.

URL: <http://www.kowa-europe.com/>

Per lo smaltimento di questo prodotto

Un metodo di smaltimento corretto per la salvaguardia dell'ambiente è specificato per legge e il prodotto deve essere raccolto in modo differenziato. A fine uso, disfarsi del prodotto seguendo la procedura indicata nel sito web seguente. Senza accesso al sito web, rivolgersi al proprio rivenditore di fiducia.

URL: <http://www.kowa-europe.com/>

Šim izstrādājumam paredzētā iznīcināšanas procedūra

Videi draudzīgo šī produkta iznīcināšanas procedūru nosaka likumdošana, un tam nepieciešama atsevišķa, iznīcināšanai paredzēta, savākšana. Lūdzu, izmetiet šo produktu atbilstoši šajā interneta lapā norādītajai procedūrai. Ja Jūs nevarat piekļūt šai interneta lapai, lūdzu, sazinieties ar savu dīleri.

URL: <http://www.kowa-europe.com/>

Šio gaminio išmetimo procedūra

Nežalingą aplinkai šio gaminio išmetimo būdą apibrėžia įstatymas ir išmetimui jį reikia išvežti atskirai. Šį gaminį išmeskite pagal šioje svetainėje nurodytą procedūrą. Jeigu negalite pasinaudoti šia svetaine, prašome susisiekti su savo prekybos agentu.

URL: <http://www.kowa-europe.com/>

Procedura ta' rimi għal dan il-prodott

Metodu ta' rimi li ma jagħmilx hsara lill-ambjent huwa speċifikat bil-liġi għal dan il-prodott u dan għandu jingabar individwalment biex jintrema'. Armi dan il-prodott skond il-procedura riferita fil-websajt li għejja. Jekk ma tistax tfttix fil-websajt, jekk jogħġbok ikkuntattja lin-negozjant li minn għandu xtrajtu.

URL: <http://www.kowa-europe.com/>

Procedura utylizacji produktu

Odpowiednią, przyjazną dla środowiska metodę utylizacji tego produktu określają przepisy prawne. Produkt należy utylizować zgodnie z procedurą podaną w poniższym serwisie WWW. Jeżeli skorzystanie z podanego serwisu WWW nie jest możliwe, prosimy o kontakt z lokalnym przedstawicielem.

URL: <http://www.kowa-europe.com/>

Procedimento de eliminação para este produto

O método de eliminação sem prejudicar o meio ambiente é especificado pela lei aplicável a este produto e este deve ser eliminado individualmente. Elimine este produto de acordo com o procedimento referido no seguinte website. Caso não consulte o website, contacte o seu vendedor.

URL: <http://www.kowa-europe.com/>

Postup odstránenia tohto výrobku do odpadu

Zákonom je pre tento výrobok stanovený spôsob odstránenia do odpadu tak, aby nedošlo k poškodeniu životného prostredia a preto sa musí individuálne zbierať do odpadu. Odstráňte prosím tento výrobok do odpadu podľa postupu, ktorý je uvedený na nasledovnej webovej stránke. Ak nemáte prístup k tejto webovej stránke, skontaktujte sa prosím s predajcom.

URL: <http://www.kowa-europe.com/>

Postopek odstranitve za ta izdelek

Okolju prijazen postopek odstranjevanja je določen z zakonom za ta izdelek in mora biti zbran individualno za odstranitev. Prosimo, odvrzite ta izdelek ustrezno s postopkom, ki je opisan na sledeči spletni strani. V kolikor nimate dostopa do spletne strani, prosimo, da se obrnete na vašega trgovca.

URL: <http://www.kowa-europe.com/>

Procedimiento para desechar este producto

La ley prevé un método ecológico específico para desechar este producto, el cual debe recogerse en forma individual para su descarte. Respete este procedimiento, de acuerdo con el siguiente sitio Web. Si no puede consultar el sitio Web, contacte con el distribuidor.

URL: <http://www.kowa-europe.com/>

Procedur för att kasta bort denna produkt

Miljövänliga källsorteringsmetoder ska enligt lag användas för denna produkt och delarna måste sorteras individuellt innan de kastas bort. Vänligen gör dig av med denna produkt i enlighet med proceduren som beskrivs på följande webbplats. Om du inte kan nå webbplatsen, ska du kontakta din återförsäljare.

URL: <http://www.kowa-europe.com/>



Technology for Life Science

 *Kowa Company, Ltd.*

World Sales Headquarters

4-14, Nihonbashi-honcho 3-chome, Chuo-ku, Tokyo 103-8433, Japan
Phone : +81(3)3279-7639
Facsimile : +81(3)3279-7541
E-mail : life@kowa.co.jp
URL : <http://www.kowa.co.jp/e-life/>



Kowa Company, Ltd. Hamamatsu Factory
3-1, Shinmiyakoda 1-chome, Kita-ku, Hamamatsu City,
Shizuoka Pref., 431-2103, Japan



Kowa Optimed Europe Ltd.

Sandhurst House, 297 Yorktown Road, Sandhurst, Berkshire GU47 0QA, U.K.
Phone : +44(127)693-7021
Facsimile : +44(127)693-7023
E-mail : info@kowaoptimed.com
URL : <http://www.kowa.eu>

Kowa Optimed Deutschland GmbH

Bendemannstrasse 9, 40210 Duesseldorf, Germany
Phone : +49(211)54218400
Facsimile : +49(211)54218410
E-mail : medical@kowaeurope.de
URL : <http://www.kowa.eu>