

Hand-Held Slit Lamp

KOWA SL-19

INSTRUCTION MANUAL



US



Introduction

Congratulations on your purchase of the KOWA SL-19 (Basic Model).

This manual provides a description of the operating procedures and important precautions to be observed during its use.

Please read this manual carefully to ensure that the instrument can perform to its full capabilities and work safely. After you have finished reading, keep this manual in an easily accessible location for future reference.

Safety Precautions

This manual describes important precautions to be observed when you use the instrument to ensure that the instrument is used safely without causing any damage to the human body or property of the purchaser and other persons.

The following designations and pictorial symbols should be fully comprehended before reading the manual.

Meanings of Designations



Warning

Improper operation may result in serious injury^{*1} or death.



Caution

Improper operation may result in bodily injury^{*2} or property damage^{*3}.

*1 Serious injury means vision loss, an injury, high- or low-temperature burn, electrical shock, fracture, or poisoning that causes a subsequent complication or requires hospitalization or long-term outpatient treatment.

*2 Bodily injury means an injury, burn, electrical shock and so forth that will not necessitate hospitalization or long-term outpatient treatment.

*3 Damage to property means extensive damage to a house and/or household goods as well as a domestic animal and pet.

Meanings of Symbols



Graphical indication of any warning and caution.

What is warned is explicitly and pictorially indicated by a picture or its associated message on or near a pictorial symbol.



Graphical indication of prohibited operation (prohibitive item).

What is prohibited is explicitly and pictorially indicated by a picture or its associated message on or near a pictorial symbol.



Graphical indication of any mandatory action (obligatory item).



What must always be done is explicitly and pictorially indicated by a picture or its associated message on or near a pictorial symbol.

Disclaimer



KOWA is not responsible for:

- Any damage caused by fire, earthquake, third party action, abuse or use under abnormal conditions, or any accident caused by a user's intentional or unintentional error.
- Any incidental damage resulting from use of the product or its malfunction (e.g. loss of operating profit, business disruption, change/loss of stored data and so forth).
- Any damage resulting from disregarding what is described in this manual.
- Any damage resulting from malfunctioning caused by a combination of connected devices.

⚠ Warning

 Prohibitory	Do not place a container or cup containing liquid near the instrument. Spilled liquid entering into the instrument may cause electrical shock. If liquid should be spilled into the instrument, contact KOWA or an authorized KOWA dealer for inspection.
	Do not touch the battery box with a wet hand. Otherwise, it may cause electrical shock.
	Do not short-circuit the terminals of the instrument or battery box. Otherwise, it may cause fire or electrical shock.
	Do not disassemble, modify or repair the instrument by yourself. Otherwise, fire, electrical shock, bodily injury, or instrument malfunction may occur. Refer all servicing to KOWA or authorized KOWA dealer. The instrument disassembled, modified or repaired by anyone other than a KOWA designated repair facility will void the warranty.
 Obligatory	If an unusual smell, unusual noise, overheating, or smoke is generated when the slit button is turned on, turn off the slit button immediately. Continuous use may result in fire or instrument damage. Contact KOWA or authorized Kowa dealer for inspection.
	Use the designated battery box. Use of a battery box other than the designated one may cause fire or malfunction.
	Remove the batteries when they are exhausted or when the unit will not be used for a long period of time (more than three months). Leaving the battery in the unit for a long time may cause battery fluid leakage. Remove used batteries and replace them with new ones at the same time. The Ni-MH battery and its charger are not medical devices. Please contact the battery/charger manufacturer for trouble with the nickel metal hydride battery or its charger.

⚠ Caution

 Prohibitory	Do not wipe the exterior with benzene, thinner, or ethanol. It may lead to discoloration or deterioration. If the terminals are soiled, wipe with a dry soft cloth containing.
	Do not place your hands between the revolving arm and the coupled arm. It may lead to injury if the hand is caught when the arms move.
	Do not put your fingers between the prism boxes. The hand may be caught and lead to injury when adjusting interpupillary distance.
	Do not place this device or charger on an unstable surface, such as a wobbly or tilted surface. The device may fall and could cause injury.
	Do not use the product in humid, dusty, oily smoke, or steamy locations. Using the device in such environments could lead to fire or electric shock.
	Attach the battery box properly. A dropped battery box may cause damage or injury.
 Obligatory	When using or carrying the instrument, hold it firmly. Dropping the instrument may lead to injury.
	Do not use this device in a low-temperature environment below 10°C or in a high-temperature environment above 35°C. It may cause damage to the device.
	When using the forehead rest, securely tighten the fitting screws and fastening screws to prevent them from loosening and install them correctly. Loose or detached parts may cause injury.

Components and Supplies

Main unit and standard items

Main unit (including battery box): 1

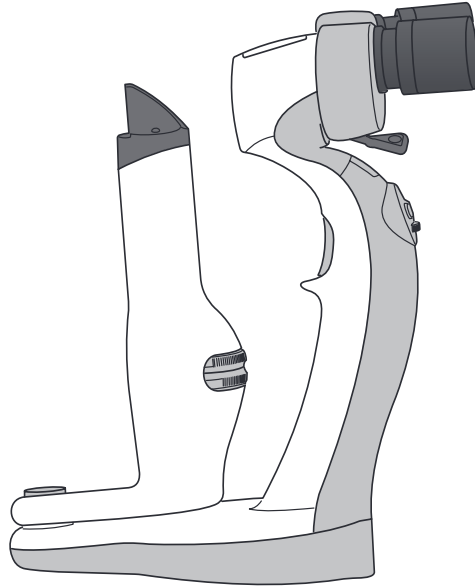

Batteries

Dust cover: 1

Other

Dry Cell Battery:3

*For operation check.
Depending on the country / region,
these may not be included.

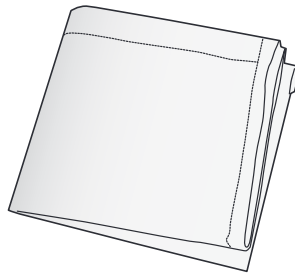

Instruction Manual: 1

Optional items

Forehead rest
(Model: SL-HR150): 1

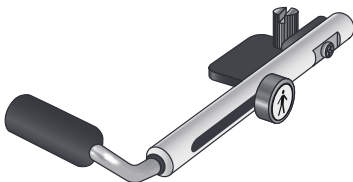

Meanings of Symbols

Main unit

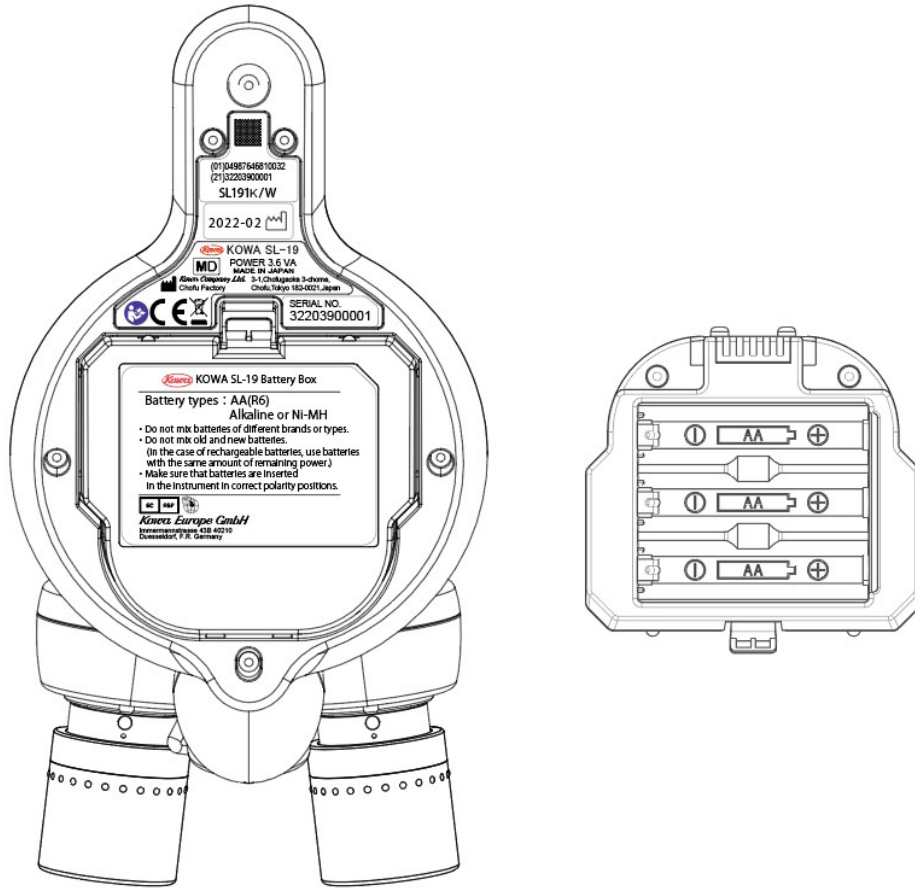

Forehead rest (optional item)

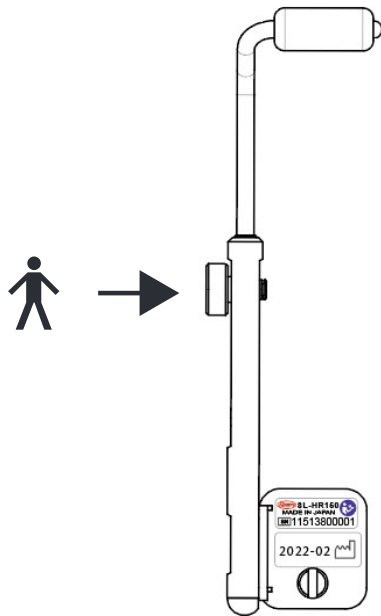

	Symbol for "Follow instruction manual for use"		Symbol for "To Recycle"
	Symbol for "DATE OF MANUFACTURE"		Symbol for "Medical Device"
	Symbol for "MANUFACTURER"		Symbol for "Serial number"
	Symbol for "Authorised Representative in the European Community"		Symbol for "Type B applied part"
	Symbol for "Importer"		Indicates the size of the battery and the polarity when it is used.

Operating Precautions

1. Operating environment

- 1) Avoid high temperature and humidity, direct sunlight, and dust when transporting, installing and storing the instrument. Strictly observe the following environmental conditions.

	Operational	Transport and storage
Environmental temperature	10 to 35°C	- 10 to + 55°C
Relative humidity	30 to 90%	10 to 95%
Atmospheric pressure	800 to 1,060 hPa	700 to 1,060 hPa

- 2) Avoid condensation when using, transporting or storing the instrument.

2. Precautions for maintenance and repair

- 1) Disinfect all parts accessible by the patient with alcohol.
- 2) Handle the instrument carefully and do not subject it to strong impact. Do not operate the instrument after it has been dropped or has been subjected to any other kind of strong impact.
- 3) When the instrument has not been used for a long period of time, inspect the items below.
 - Severe damage or deterioration of the exterior
 - Deterioration or leaking of batteries
- 4) Never disassemble or adjust this instrument by yourself as it involves precision parts which require special tools.
- 5) KOWA is not liable for malfunction and/or damages resulting from maintenance and/or repairs performed by a third party other than an agent authorized by KOWA.
- 6) KOWA is not liable for malfunction and/or damages resulting from maintenance and/or repairs using parts other than repair parts specified by KOWA.
- 7) Always cover this instrument with the dust cover when not in use.
- 8) Prevent running out of batteries by having new batteries prepared.

3. Disposal precautions

Disposal of this device, battery is subject to local laws concerning waste treatment and cleaning. When disposing, be sure to contact a licensed industrial waste disposal contractor in accordance with local government ordinances and regulations if applicable.

4. Notes on Batteries and Rechargeable Batteries

- 1) This device uses three AA batteries. Please follow the guidelines below.
 - For dry cell batteries (primary batteries), use Alkaline batteries.
 - When using a rechargeable battery, use a rechargeable nickel metal hydride battery.
 - Do not use new and old batteries together, or batteries of different brands or types together.
 - Make sure that batteries are inserted in the battery box in correct polarity positions. Batteries inserted in the wrong direction may lead to failure.
 - For dry batteries and rechargeable batteries that we recommend, please contact Kowa or your local Kowa dealer.
 - When using rechargeable batteries, always use the charger recommended by the battery manufacturer.
 - Read respective instruction manuals for precautions on batteries and chargers.
- 2) Always take the following precautions to avoid serious injury or fire caused by overheating, ignition, explosion, or fluid leakage.
 - If overheating occurs, immediately move away from the instrument. Leaked fluid or the instrument may catch fire and explode.
 - If battery fluid gets into the eyes, flush with clean water and see a doctor immediately.
 - If your body or clothes are contaminated with battery fluid, wash thoroughly.

5. Prescription device caution (For US market)



Caution Federal law restricts this device to sale by or on the order of a Physician or Practitioner.

Warning



Obligatory

Remove batteries when the batteries have run out, or when the instrument will not be used for extended periods (three months or longer).
Leaving the batteries inside the instrument for extended periods may cause leakage of battery fluid. When batteries have run out, remove all the batteries inside and replace with new ones.
The Ni-MH battery and its charger are not medical devices.
Please contact the battery/charger manufacturer for problems with the nickel metal hydride battery and its charger.

Operational Considerations for a Hospital Grade Electrical Instrument (safety and accident prevention)

- 1. Only qualified personnel should operate this instrument.**
- 2. The following items shall be considered when installing the instrument.**
 - 1) Install at a location away from water or accidental splashing.
 - 2) Install at a location which will not be adversely affected by atmospheric pressure, temperature, humidity, ventilation, sunlight, dust, and air containing salt, sulfur and other substances, and the like.
 - 3) Take care to guard against tilt, vibration, and strong impacts, for instance, during transportation.
 - 4) The instrument must not be installed at locations where chemicals are stored or gasses are generated.
 - 5) Check the status of the batteries (electrical discharge, polarity, etc.).
- 3. The following items shall be considered before using the instrument.**
 - 1) Make sure that the instrument activates properly after checking switch contact, polarity, dial setting and so forth.
 - 2) Use of other instruments and appliances on the same power outlet is liable to cause errors and incorrect output resulting in incorrect diagnosis or hazards.
 - 3) Before operation, make sure that the battery is sufficiently charged.
- 4. The following items shall be considered when using the instrument.**
 - 1) Make sure to minimize the time required for diagnosis.
 - 2) Always ensure that the instrument and patient are in good condition.
 - 3) When an abnormality is found on the instrument, take proper measures. For instance, stop the operation of the instrument while assuring the patient's safety.
 - 4) Do not allow the patient to touch any part of the instrument except for the forehead rest.
- 5. The following items shall be considered after using the instrument.**
 - 1) The following shall be considered regarding storage location.
 - (i) Store at a location away from water or accidental splashing.
 - (ii) Store at a location which will not be adversely affected by atmospheric pressure, temperature, humidity, ventilation, sunlight, dust, air containing salt, sulfur and other substances, and the like.
 - (iii) Take care to guard against tilt, vibration, and strong impacts, for instance, during transportation.
 - (iv) The instrument must not be stored at locations where chemicals are stored or gasses are generated.
 - 2) Clean and rearrange items, and the like.
 - 3) The instrument must be cleaned after use so that there will be no problems when using it again.
- 6. In case of a problem or malfunction, do not attempt to repair the instrument by yourself. Appropriately label the instrument as “out of order” and contact a qualified technician for repair.**
- 7. The instrument shall not be modified.**
- 8. Maintenance**
 - 1) Periodically check the instrument and its components for any abnormality.
 - 2) When using the instrument after it has not been used for a while, check beforehand to ensure that it is in normal condition and operates safely.
- 9. Be careful of the possibility that incorrect operation may be caused by strong electromagnetic waves.**

This instrument is examined based on IEC60601-1-2.

The purpose of this standard is to keep safety against the dangerous obstacle in typical medical facilities.

In case this instrument is influenced by other instrument, or it affects other instrument or there is such fear, relocate this instrument and other apparatus or extend the distance between those instruments.

If you have any questions, please consult KOWA or an authorized KOWA dealer.

Light Hazard

The KOWA SL-19 (Basic Model) is classified as a Group 2 device in ANSI Z80.36-2016. Refer to the following for a thorough understanding.

CAUTION: The light emitted from this instrument is potentially hazardous. The longer the duration of exposure, the greater is the risk of ocular damage. Exposure to light from this instrument when operated at maximum intensity will exceed the recommended maximum exposure(RME) of 2.2 J/cm² , unless additional action is taken by the user to minimize exposure, after 2.1min for source 1, 58.8 min for source 2 and 13.9 min for source 3.The risk of retinal injury at an exposure of 2.2 J/cm² is not high, but because some patients may be more susceptible than others, caution is advised if this radiant exposure value is exceeded However, because of a significant risk of injury at exposures exceeding 10 J/cm² , the user should avoid exposures longer than 9.5 min for source 1, 267.2 min for source 2 and 63.2 min for source 3.

NOTE 1 The exposure from all light sources is cumulative and additive.

NOTE 2 If the intensity of any of the light sources is reduced to 50% of the maximum intensity, the exposure time for that light source to reach the exposure limit is doubled. This linear relationship can be used to determine the time to reach the exposure limit for the combination of light sources at various intensity settings.

Slit light(source1)

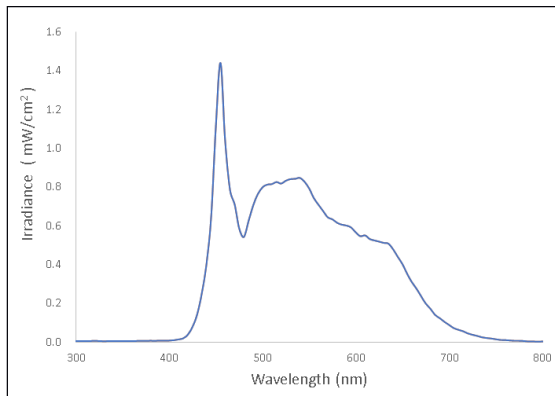

Light intensity dial display	1	2	3	4	5
Light intensity ratio	0.01	0.03	0.18	0.55	1.00

Background illumination light(source2)

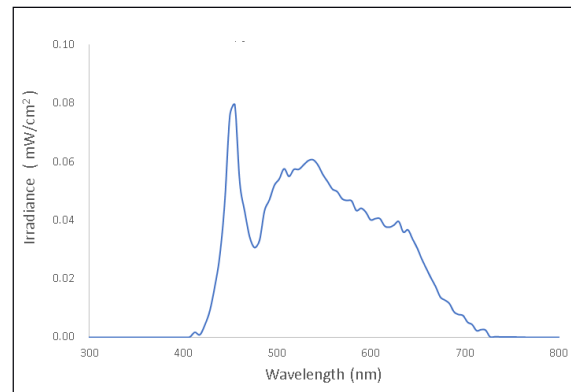

Background illumination stage	1	2	3
Light intensity ratio	0.14	0.50	1.00

Blue illumination light(source3)

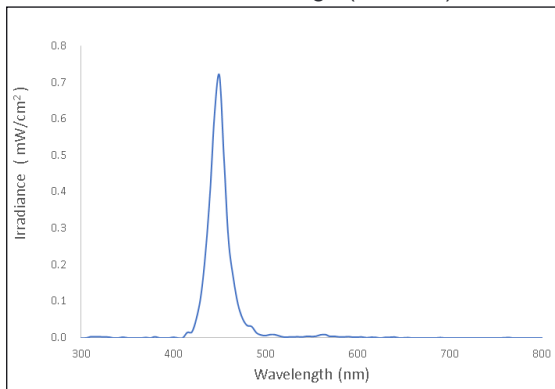

Blue illumination stage	1	2	3
Light intensity ratio	0.21	0.50	1.00

Electromagnetic Compatibility

This instrument is a medical electrical instrument. Medical electrical instruments require special attention to electromagnetic compatibility (EMC).

The following section describes the conformity to EMC and precautions for this instrument. When installing or using this instrument, read the description carefully and follow the directions described.

(The EMC of this instrument was tested based on IEC 60601-1-2.)

- The environment for which this instrument is suitable: Home healthcare facility environment.
- The performance in the following table is verified to determine electromagnetic compatibility (EMC) of this instrument.

Performance	Switching ON/OFF the lamp
-------------	---------------------------

Warning

What can be anticipated if the performance is lost or degraded due to electromagnetic disturbances: The lamp is not turned on. Use of this instrument adjacent to or stacked with other instrument may lead to the improper functioning. If such use is necessary, this instrument and the other instrument should be observed to verify that they are operating normally.

Warning

This device has been tested for electromagnetic compatibility (EMC) in conjunction with the following items and peripheral devices. Use of non-designated items may increase the electromagnetic emission of this device or reduce the electromagnetic immunity, resulting in improper operation. Do not attach and use substances that are not designated.

- Forehead rest (SL-HR150)
- KOWA SL-19 charger (SL-CB191)*
- KOWA SL-19 power pack (SL-PP191)*
- AC adaptor (adapted from IEC62368) (GCF312S-0520 manufactured by GUCF)
- USB cable (not more than 1.5m) (Elecom U2C-AC15NBK)

*Depending on the country / region, the above items may not be available.

Warning

Portable RF communications instrument (including peripherals such as antenna cables and external antennas) should be used no closer than 30 cm (12 inches) to any part of this instrument, including cables specified. Otherwise, degradation of the performance of this instrument could result.

Electromagnetic Compatibility

<Main body and Forehead rest>

Compliance for each emissions

Emissions Test	Compliance
RF emissions CISPR 11	Group 1 Class B
Conductive emission CISPR 11	Not applicable
Harmonic distortion IEC 61000-3-2	Not applicable
Voltage fluctuations and flicker IEC 61000-3-3	Not applicable

Compliance for each immunity

Immunity Test	Immunity Test Levels
Electrostatic Discharge IEC 61000-4-2	±8 kV contact ±2 kV, ±4 kV, ±8 kV, ±15 kV air
Radiated RF EM fields IEC 61000-4-3	10 V/m 80 MHz – 2.7 GHz 80 % AM at 1 kHz
Rated power frequency magnetic fields IEC 61000-4-8	30 A/m 50 Hz or 60 Hz
Electrical fast transients/bursts IEC 61000-4-4	Not applicable
Surges IEC 61000-4-5	Not applicable
Conducted disturbances induced by RF fields IEC 61000-4-6	Not applicable
Voltage dips IEC 61000-4-11	Not applicable
Voltage interruptions IEC 61000-4-11	Not applicable
Electrical transient conduction along supply lines ISO 7637-2	Not applicable
Proximity fields from RF wireless communications equipment IEC 61000-4-3	See “Test specifications for enclosure port immunity to RF wireless communications equipment”.

Test specifications for enclosure port immunity to RF wireless communications equipment

Test Frequency (MHz)	Band (MHz)	Service	Modulation	Maximum Power (W)	Distance (m)	Immunity Test Level (V/m)
385	380 – 390	TETRA 400	Pulse modulation 18Hz	1.8	0.3	27
450	430 – 470	GMRS 460, FRS 460	FM ±5 kHz deviation 1 kHz sine	2	0.3	28
710	704 – 787	LTE Band 13, 17	Pulse modulation 217 Hz	0.2	0.3	9
745						
780						
810	800 – 960	GSM 800/900, TETRA 800, iDEN 820, CDMA 850, LTE Band 5	Pulse modulation 18 Hz	2	0.3	28
870						
930						
1720	1700 – 1990	GSM 1800; CDMA 1900; GSM 1900; DECT; LTE Band 1, 3, 4, 25; UMTS	Pulse modulation 217 Hz	2	0.3	28
1845						
1790						
2450	2400 – 2570	Bluetooth, WLAN, 802.11 b/g/n, RFID 2450, LTE Band 7	Pulse modulation 217 Hz	2	0.3	28
5240	5100 – 5800	WLAN 802.11 a/n	Pulse modulation 217 Hz	0.2	0.3	9
5500						
5785						

Contents

Introduction	I
Components and Supplies	III
Meanings of Symbols	IV
Operating Precautions	VI
Operational Considerations for a Hospital Grade Electrical Instrument (safety and accident prevention).....	VII
Light Hazard	VIII
Electromagnetic Compatibility	IX
Contents	XII
1 Instrument Description	1
1.1 Indications for Use	1
1.2 Contraindications	1
1.3 Overview	1
1.4 Operator	1
1.5 Features	1
1.6 Name and Function of Each Part	2
2 Preparation	4
2.1 Installing batteries in the main unit	4
2.2 Adjusting Interpupillary Distance and Diopter	5
3 How to Use	6
3.1 Basic instruction	6
3.2 How to Operate Other Functions	6
3.3 Optional items	8
4 Maintenance and Inspection	9
4.1 Regular Maintenance	9
4.2 Daily Inspection	9
4.3 Replacing Batteries	10
4.4 Cleaning	11
5 Troubleshooting	12
6 Specifications	13

1.1 Indications for Use

The KOWA SL-19 is intended for use in eye examinations of the anterior eye segment, from the cornea epithelium to the posterior capsule. It is used to aid in the diagnosis of diseases or trauma which affect the structural properties of the anterior eye segment.

1.2 Contraindications

This device is contraindicated to the following patients.

- BIRTH THROUGH 21 YEARS OF AGE
- Patients who are hypersensitive to light
- Patients who recently underwent photodynamic therapy (PDT)
- Patients who take medication that causes photosensitivity

1.3 Overview

The KOWA SL-19 (basic model) is a hand-held slit lamp powered by three AA batteries.

1.4 Operator

Persons with specialized knowledge of ophthalmic care and who received introductory education of slit lamp observation are required to operate this instrument.

1.5 Features

- Slit lamp button that allows the operator to turn on the slit lamp easily with simple action
- White LED used as the light source
- Light intensity dial that can freely change the brightness of the slit illumination
- Equipped with background illumination separately used from the slit light
- Equipped with blue color light for fluorescent staining observation

- One-action lever to change observation magnification between 10x and 16x
- Easy-to-grip shape
- Lighter than conventional models

- Power-saving LED for longer operating time
- Indicator blinks orange when the battery level is low

- Can also be used as an indirect ophthalmoscope light source

1.6 Name and Function of Each Part

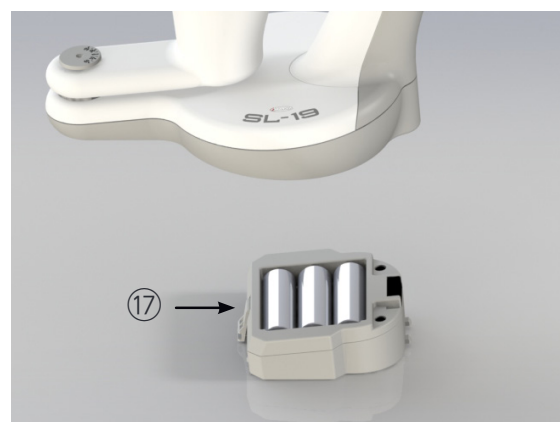
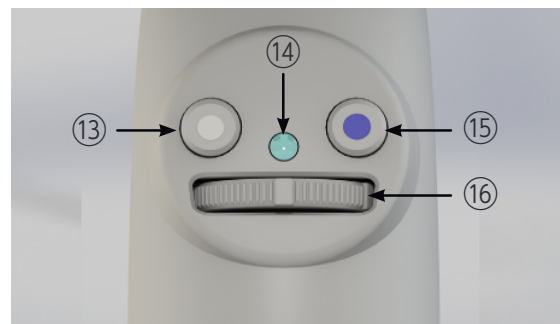
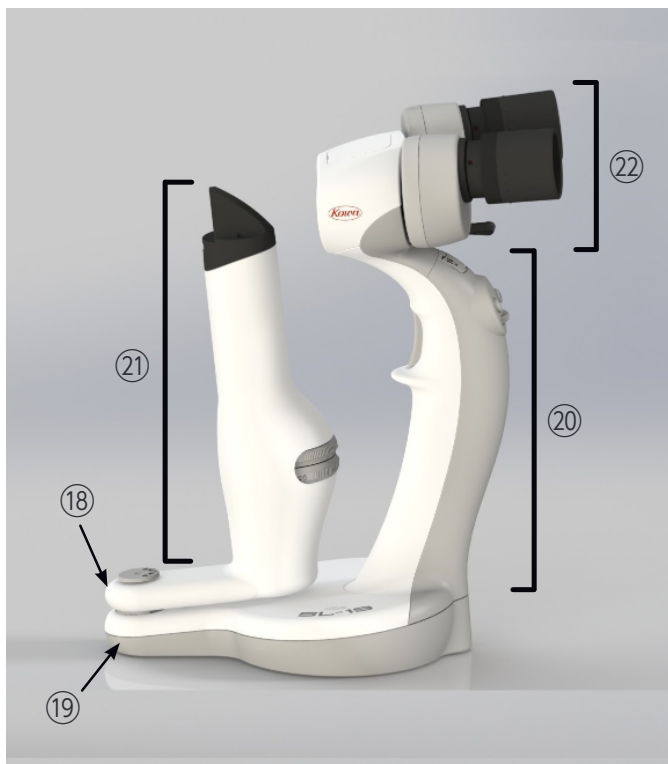
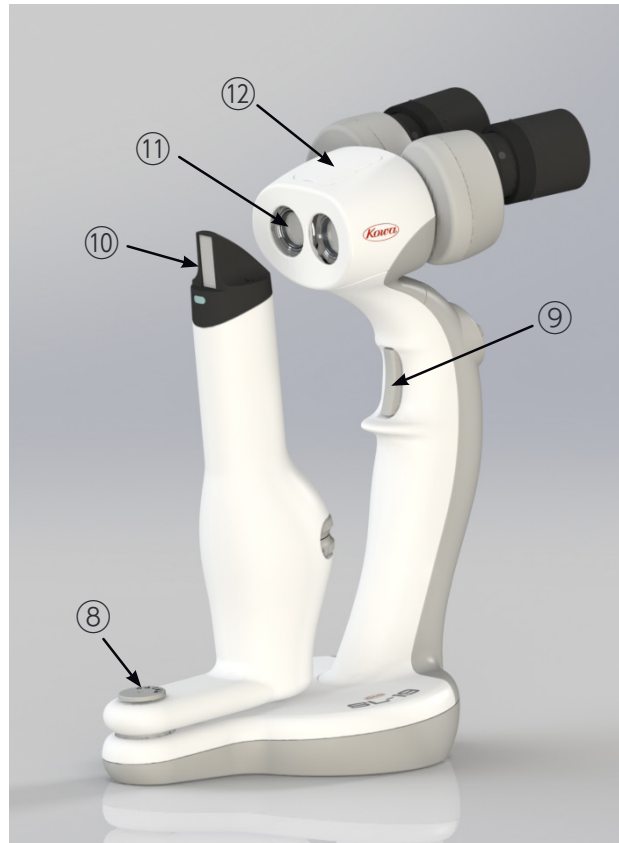

	Name	Function and performance
①	Slit dial	Select slit width and spot. Three slit widths are available: 0.1 mm, 0.2 mm, and 0.8 mm.
②	Spot dial	Select the light diameter of the spot and determine the length of the slit light. Three spot diameters (ϕ 1mm, ϕ 5mm and ϕ 12mm) can be selected and slit lengths can be changed from 1.5mm to 12mm continuously.
③	Magnifying power select lever	2 different magnifications (10x and 16x) are selectable by shifting the lever left and right.
④	Eyepiece	Ocular lenses are included in the eyepiece. The user observes patient eye through the ocular lens.
⑤	Eye cup	Attached to the eyepiece and can be used as guide to adjust the distance of the eye from the ocular lens.
⑥	Dioptric correction scale	Continuously adjust the dioptric power of the eyepiece.
⑦	Prism box	Rotate left and right to adjust interpupillary distance.
⑧	Illumination angle scale	Indicates the swing angle of the illumination light.
⑨	Slit lamp button	Press to turn ON the light, and release to turn OFF.
⑩	Projection prism	Part of prism where the illumination light passes through.
⑪	Objective lens	At 10x magnification, the objective lens stays inside the microscope unit and at 16x magnification, the objective lens pops out forward.
⑫	Upper cover	Remove the upper cover when installing the forehead rest.
⑬	Back light button	When pressed, the background illumination light turns on. The light intensity can be switched between three levels.
⑭	Main unit indicator	Illuminated in green when the unit is turned on. Flashes orange when the battery level is low.
⑮	Blue light button	Press to turn on the blue light for fluorescence observation. The light intensity can be switched between three levels.
⑯	Light intensity dial	The brightness of the illumination light can be continuously adjusted. Turn to the right to make it brighter, turn to the left to make it darker.
⑰	Battery box	Can contain batteries to be attached to insert the battery into the main unit.
⑱	Revolving arm	—
⑲	Coupled arm	Supporting connection between the grip unit and the illumination unit.
⑳	Grip	—
㉑	Illumination unit	—
㉒	Microscope unit	—

2.1 Installing batteries in the main unit

When using alkaline dry batteries or Ni-MH rechargeable batteries

- (1) While pressing the tab, pull the battery box to remove it from the main unit.

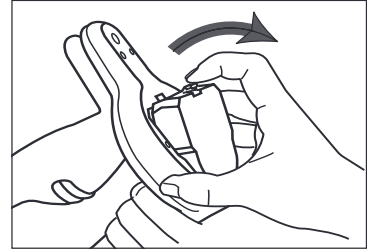

- (2) Firmly insert batteries in correct polarity positions as written on the battery box.

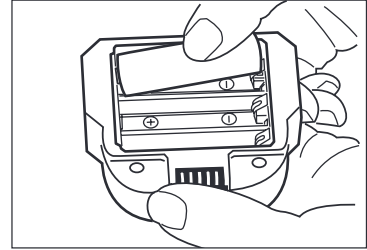

Recommended Batteries

Shape	AA
Type	Alkaline dry batteries or Ni-MH rechargeable batteries

⚠ Caution



Prohibitory

Do not mix different types of batteries.
Do not mix batteries with different residual volumes.

- (3) Return the battery box to the main unit.
Insert the battery box until the tab makes a click sound.

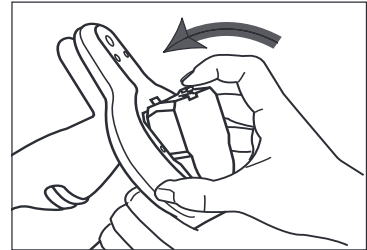

⚠ Caution



Obligatory

If this device is used with the battery box not inserted securely, the battery box may fall, resulting in damage or injury.

- (4) Press the slit lamp button and confirm that the main unit indicator lights in green.

2.2 Adjusting Interpupillary Distance and Diopter

(1) Adjusting interpupillary distance

Adjust the interpupillary distance by rotating the prism box left or right to obtain an appropriate field of view through the eyepieces.

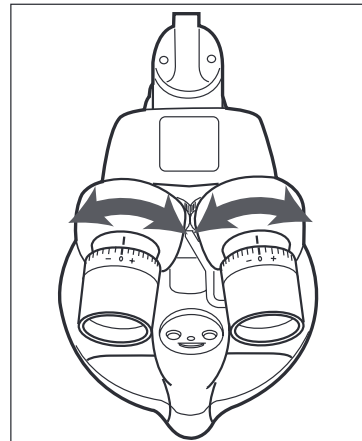
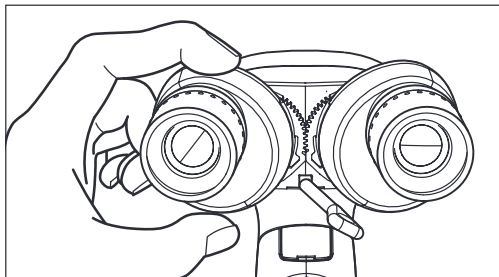

⚠ Caution



Prohibitory

Do not adjust the interpupillary distance with fingers placed between the prism boxes.

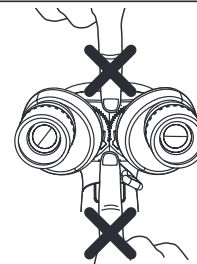

(2) Adjustment of the diopter

Make adjustment for each eye according to the following procedure.

- Turn the dioptic correction scale all the way to the “+” side.
- Looking in the finder, slowly turn the dioptic correction scale toward the “-” side until the reticle is clearly visible.

When you are wearing eyeglasses, you may fold back the eye cups.

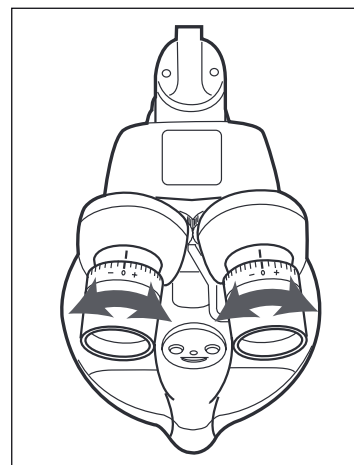

Reticle Visibility



3.1 Basic instruction

- (1) Using the grip, hold the main unit securely in your hand.
- (2) Place the thumb of the other hand on the side of the microscope unit and place the other fingers on the patient's forehead.
- (3) Stabilize slit width indication by adjusting the distance between the examined eye and the objective lens, depending on how wide the opening is between the thumb and the other fingers when put on the patient's forehead.

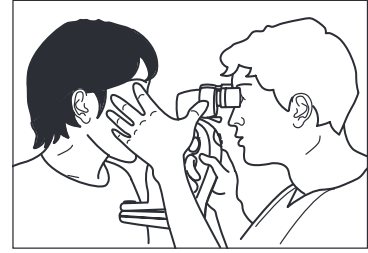

Use of the forehead rest (optional item) to fix the position of the patient and the device, and makes it possible to observe the patient eye.

- (4) Press the slit lamp button and irradiate the light for various observations of the eye.

3.2 How to Operate Other Functions

- Changing observation magnification
Turn the magnifying power select lever to the left as indicated by the arrow to select a magnifying power of 16x.
Turn it to the right to select a magnifying power of 10x.

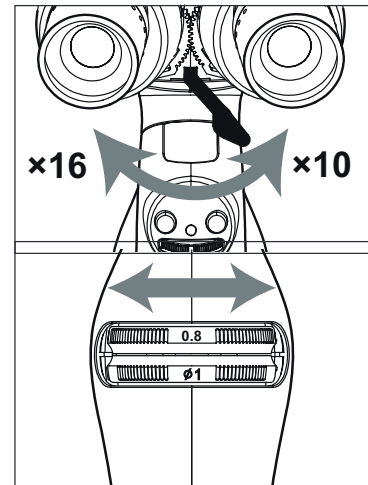

- Changing slit-width
Types of slit width: 0.1 mm, 0.2 mm, 0.8 mm and spot (circular).
Turn the slit dial and set at the click stops.

- Select the slit length and spot diameter
The slit length/spot diameter can be switched between ϕ 1 mm, ϕ 5 mm and ϕ 12 mm.
The slit length can also be varied continuously from 1.5mm to 12 mm.
Turn the spot dial and set it at the click stops or adjust it to the appropriate slit length.

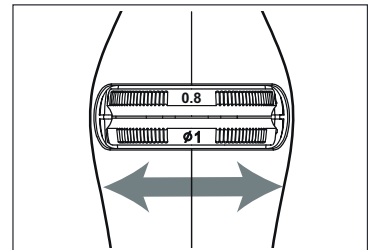

List of slit dial and spot dial settings

No.	1	2	3	4	5	6
Illumination irradiated						
Slit dial	0.1, 0.2, 0.8	0.1, 0.2, 0.8	0.1, 0.2, 0.8	○	○	○
Spot dial	12	ϕ 1, ϕ 5	1.5↔12	12	ϕ 1, ϕ 5	1.5↔12

IMPORTANT

- Light other than slits and spots may be irradiated as shown in No.6. This is not a malfunction.

- **Adjust the slit light intensity**
Turn the light intensity dial to the right to make it brighter and left to make it darker.

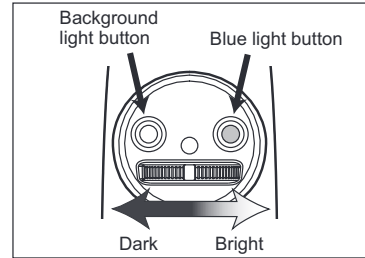

- **Use background lighting**
Press the back light button to turn on the background illumination light.
The brightness can be changed between three levels by pressing the button.
When the button is pressed 4 times, the light turns off.
*The slit light can be turned on or off when the background light is on.
*If no operation state lasts for 10 minutes, the light turns off automatically.

- **Use blue lighting**
Press the blue light button to turn on the blue illumination light.
The brightness can be changed between three levels by pressing the button.
When the button is pressed 4 times, the light turns off.
*The slit light can be turned on or off when the background light is on.
*If no operation state lasts for 10 minutes, the light turns off automatically.

- **Adjust the angle of illumination**
Hold the lower part of the illumination unit below the slit dial and the spot dial, and turn the revolving arm parallel with top of the coupled arm.
The illumination angle can be adjusted around the rotation axis.
The lighting angle can be checked by the Illumination angle scale.

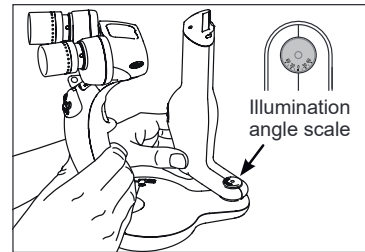

⚠ Warning



Do not touch the area around the projection prism while light is being emitted as it becomes hot.



⚠ Caution



Do not lift the device with the illumination unit.
Do not pull the revolving arm up with the coupled arm.

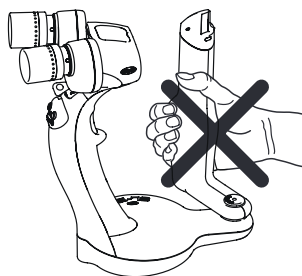

Do not insert a finger between the revolving arm and the coupled arm and turn the rotating arm.

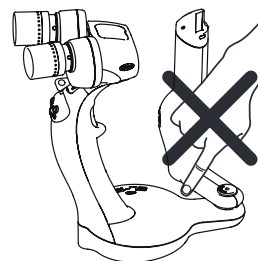

3.3 Optional items

3.3.1 Forehead rest

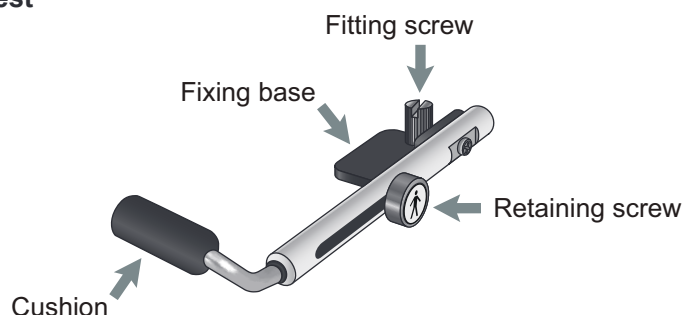

(1) Insert an object with a narrow tip into the gap on the top surface of microscope unit to open the upper cover and remove it.

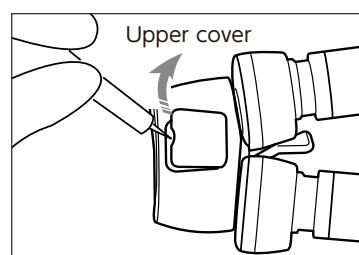

(2) Attach the fixing base to where the upper cover was attached and tighten the fitting screw to secure it.

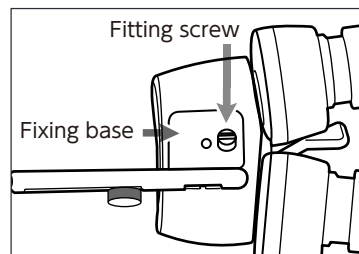

⚠ Caution



Obligatory

When operating the forehead rest, tightly fasten the fitting screw beforehand to keep from slackening during operation. Otherwise, the forehead rest may accidentally jerk forward and cause injury.

(3) Adjusting the position of the forehead rest

When the retaining screw is loosened, the cushion moves toward the patient.

Place the cushion on the patient's forehead, approach slowly while viewing, and adjust the distance.

Tighten the retaining screw in appropriate position to facilitate stable observation.

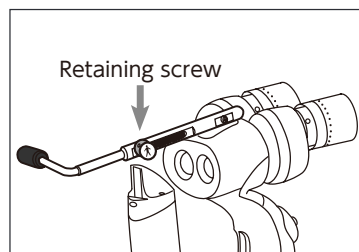

⚠ Caution



Obligatory

When using the forehead rest retaining screw, firmly tighten the retaining screw so that it will not come loose. If the forehead rest suddenly comes out, it may lead to injury.

4

Maintenance and Inspection

This instrument is a precision instrument and not performing regular maintenance and daily inspection may affect the imaging results.

Please read this section carefully in order to use this instrument correctly and safely.

⚠ Caution



Do not perform maintenance or inspection during use.

Prohibitory

4.1 Regular Maintenance

- Make sure to place the dust cover on the instrument after use.
- Take care not to allow dirt, dust, fingerprints, tears, etc. to adhere to the projection prism, objective lens, and ocular lens.
- Clean the instrument with a soft piece of cloth. For obstinate dirt, apply diluted detergent.
- If the instrument will be not used for extended periods, remove the battery box from the main unit and remove batteries from the battery box.

4.2 Daily Inspection

Follow the KOWA SL-19 (Basic Model) Daily Inspection Table for routine inspection of this device.

KOWA SL-19 (Basic Model) Daily Inspection Table			
Inspection item		Procedure	Acceptability criteria
Main unit	Enclosure	Visually verify that there is no problem.	There is no deformation.
	Projection prism Objective lens Lens of eyepieces	Visually verify that there are no flaws or contaminants on the lenses.	There are no flaws or contaminants.
	Slit lamp button	Operate and confirm that the button works correctly.	Light and main unit indicators should light up when pressed.
	Slit dial Spot dial	Move the dial to see that it moves without any problems and has clicks.	The dial should move smoothly. There should be clicks.
	Magnifying power select lever	Move the lever to see that it moves without any problems.	The lever should move smoothly.
	Light intensity dial	Move the lever to see that it moves without any problems.	The lever should move smoothly.
	Version	Visually check that the label is securely installed and that all indications are clearly visible.	The label must be securely installed. All indications must be clearly visible.
	Terminal part	Visually check if the terminal parts are soiled.	They should not be soiled or black.
Battery box	Enclosure	Visually verify that there is no problem.	There is no deformation.
	Terminal part	Visually check if the terminal parts are soiled.	They should not be soiled or black.

4.3 Replacing Batteries

The main unit indicator blinks when the battery level is low. In this case, replace the battery.

Approximate Operating Time: About 360 minutes when the slit light is continuously turned on with the light intensity dial displaying "5" (maximum intensity) and with Ni-MH Rechargeable batteries (1900mAh)

IMPORTANT

- Note that continuous lighting time will vary depending on temperature or frequency of charging.
- The capacity of the rechargeable battery gradually decreases even when not in use.
We recommend that you always have a spare battery ready for use when the remaining capacity decreases.

About the main unit indicators

Status of the indicator	Status of the main unit	How to deal with
Green	Slit light, background light, or blue light is illuminated. There is no problem with the residual capacity of battery.	When all lights are turned off, the main unit indicator also turns off.
Blinking orange	Slit light, background light, or blue light is illuminated. Low battery level.	Each light can be turned on, but the battery level is low. Replace the battery.
Off	Waiting state	When the slit lamp button is pressed and the background/blue light button is pressed, the main unit indicator is shows the remaining battery power.
		If the light does not turn on even when the slit button is pressed or the background light/blue light button is pressed, the battery level is insufficient. Replace the battery.
	The battery is not installed.	Install the battery.

4.4 Cleaning



4.4.1 Cleaning and disinfection of parts that come into contact with the patient (Forehead rest)

When you use the forehead rest (optional item), clean the cushion with disinfectant alcohol after every patient.

4.4.2 Cleaning the exterior

If the exterior is dirty, clean it using the following procedure:

- (1) Wipe the surface with a firmly squeezed, dampened soft cloth.
- (2) Wipe off obstinate dirt with a soft cloth, after dampening the cloth with a small amount of neutral detergent diluted in lukewarm water and firmly squeezing it.

 Caution	
 Prohibitory	Do not wipe the exterior with benzene, thinner, or ethanol. It may lead to discoloration or deterioration.
	Do not allow terminals to come into contact with water. Failure to do so may lead to failure. If the terminals are soiled, wipe with a dry soft cloth.

4.4.3 Cleaning the projection prism, objective lens, and eyepiece

If the projection prism, objective lens, or eyepiece becomes dirty, clean them using the following procedure:

- (1) Blow off debris or dust on the lens surfaces using a blower.
- (2) When it cannot be cleaned by step (1), moisten cleaning paper with anhydrous ethyl alcohol and lightly wipe whole surface of the lens starting from its center in a circular motion. Repeat this step several times.
- (3) If any soil cannot be removed by steps (1) through (2), contact KOWA or an authorized KOWA dealer.



Use new lens cleaning paper every time you wipe.

IMPORTANT

- Wiping the projection prism, objective lens, or lens of eyepiece without removing dust and debris beforehand may scratch the lens surface.
- Do not use chamois leather, silicon cloth, etc.
- Carefully store and handle anhydrous ethyl alcohol.
- Do not use any other agent or cloth.

5

Troubleshooting

When a problem occurs, check the items shown below first. Look for the problem from those shown in the following list and apply the applicable remedy. If the applicable remedy does not eliminate the problem or you encounter a problem that is not listed, contact KOWA or an authorized KOWA dealer.

Abnormal performance of the instrument		
Problem	What to check · State of instrument	Applicable remedy
The lamp does not illuminate when the slit button is pressed.	Is the battery box in place?	Install the battery box.
	Is the main unit indicator blinking?	Charge the rechargeable battery. Alternatively, replace the battery with a new one.
	Battery is coming out.	Firmly insert batteries in correct polarity positions.
	Are the batteries being inserted oppositely of the positive and negative marks?	Firmly insert batteries in correct polarity positions written on the battery box.
	Is the spot dial displaced?	Set the spot dial to the continuously variable range (between 1.5 and 12 displays) or to a click position.
	Is the slit dial displaced?	Align the slit dial in a click position.
	Does the light intensity dial rotate?	With the slit lamp button pressed, turn the light intensity dial to the right to make it brighter.
The lamp goes off quickly. (battery consumption is fast)	Are the batteries charged?	If you are using a rechargeable battery charge the battery.
	Are the batteries depleted?	Replace with new batteries. The rechargeable battery gradually deteriorates after repeated charging and discharging.
The slit tilts.	Is the slit dial displaced?	Align the slit dial with the location of the clip.
Part of the illumination light or slit is obscured.	Is the slit dial or spot dial displaced?	Align the slit dial or spot dial to a click position.
Light other than slits and spots are illuminated (see figure below). 	Is the slit dial set to ○ and the spot dial set between 1.5 and 12	When the slit dial is set to ○ and the spot dial is set to between 1.5 and 12, the light as shown in the left figure is emitted. This is not a malfunction. When the slit dial is set to 0.1, 0.2, or 0.8 in this state, the slit light is illuminated.
Out of focus.	Is the diopter adjustment incorrectly set at a point away from a desired value?	Adjust to an appropriated diopter.

<Main unit>

Microscope

Type of microscope	Binocular-stereoscopic-orthoscopic microscope
Angle of convergence	13°
Total magnification	10, 16X
Objective lens' working distance	Approx. 80 mm (when a magnifying power of 16 is selected) Approx. 100 mm (when a magnifying power of 10 is selected)
Practical field of view	Ø10 mm (when a magnifying power of 16 is selected) Ø15 mm (when a magnifying power of 10 is selected)
Reticles	Built-in both eyepieces
Variable power type	2-magnifying power selectable/moving objective lens type
Interpupillary distance adjustment range	55 to 72 mm
Diopter adjustment range	- 8 to + 5 D

Light-emitting section

Slit light	
Light source	White LED
Switching method	Turret
Width/Shape	0.1 mm, 0.2 mm, and 0.8 mm Spots (circular)
Slit length	1, 5, 12 mm: fixed, and 1.5 to 12 mm: continuously variable
Spot	Ø1 mm, Ø5 mm, Ø12 mm and shapes of ellipse
Light intensity adjusting	Continuously variable Minimum: 200 Lux Maximum: 20,000 Lux
Slit's illuminating angle	Horizontal circumference ± 60°
Background illumination light	
Light source	White LED
Light volume	3 Step switching
Blue illumination light	
Light source	Blue LED
Light volume	3 Step switching

Electrical Ratings

Input voltage	DC 3.6 — 4.8 V
Power consumption	3.6 VA

Other

Dimensions/Weight	107 (W)×197 (D)×238 (H) mm/620 g (No batteries)
Expected service life	8 years

<Forehead rest> Optional item

Type name	SL-HR150
Overview	KOWA SL series forehead rest

6 Specifications

Compliance Standard

- IEC 60601-1:2005+A1:2012
- IEC 60601-1-2:2014
- ANSI Z80.37:2017

Classification Equipment (based on IEC 60601-1)

- According to the type of protection against electric shock
(Internal electrical power source device)
- According to the degree of protection against electric shock
(Type B applied part) ... Forehead rest
- According to the type of protection against ingress of water as detailed in the current edition of IEC 60529.
<IPX0>
- According to the degree of safety of application in the presence of a flammable anaesthetic mixture with air or with oxygen or nitrous oxide.
(Equipment not suitable for use in the presence of a flammable anesthetic mixture with air or with oxygen or nitrous oxide)
- According to the mode of operation.
(Continuous operation)



Technology for Life Science

 *Kowa Company, Ltd.*

World Sales Headquarters

4-14, Nihonbashi-honcho 3-chome, Chuo-ku, Tokyo 103-8433, Japan
Phone : +81(3)3279-7639
Facsimile : +81(3)3279-7541
E-mail : life@kowa.co.jp
URL : <http://www.kowa.co.jp/e-life/>

Kowa Company, Ltd. Chofu Factory

3-1, Chofugaoka 3-chome, Chofu, Tokyo 182-0021, Japan

Kowa American Corporation

Medical Device Division
20001 South Vermont Avenue, Torrance, CA 90502, U.S.A.
Phone : +1(310)327-1913
Facsimile : +1(310)327-4177
E-mail : kowa-usa-info@kowa.com
URL : <http://kowa-usa.com/>