

# HETTICH EBA 200 TABLETOP CENTRIFUGE

USER MANUAL



Art. Nr. 718319  
4800753

TELEFON +49 7461 96580 0

[www.eickemeyer.com](http://www.eickemeyer.com)

veterinary technology for life  
**Eickemeyer**®

Andreas Hettich GmbH & Co. KG  
Föhrenstraße 12, D-78532 Tuttlingen / Germany  
Phone +49 (0)7461 / 705-0  
Fax +49 (0)7461 / 705-1125  
info@hettichlab.com, service@hettichlab.com  
www.hettichlab.com



© 2014 by Andreas Hettich GmbH & Co. KG

All rights reserved. No part of this publication may be reproduced without the prior written permission of the copyright owner.

Änderungen vorbehalten! , Modifications reserved! , Sous réserve de modifications ! , Con riserva di modifiche!

**AB1800DEENFRIT / 2014**

**EG-Konformitätserklärung**  
**EC Declaration of conformity**  
**Déclaration de conformité CE**  
**Dichiarazione di conformità CE**

des Herstellers / of the manufacturer / du fabricant / del costruttore  
Andreas Hettich GmbH & Co. KG • Föhrenstraße 12 • D-78532 Tuttlingen • Germany

Hiermit erklären wir in alleiniger Verantwortung, dass das bezeichnete Gerät, inklusive dem mit dem Gerät konformitätsbewertetem Zubehör laut Zubehörliste der technischen Dokumentation dieses Geräts, der Richtlinie über In-vitro-Diagnostika 98/79/EG entspricht.

We hereby declare under our sole responsibility that the designated device and its accessories, which are listed in the technical documentation for this device and whose conformity has been assessed together with the device, conform to the Directive 98/79/EC on in vitro diagnostic medical devices.

Par la présente, nous déclarons sous notre seule responsabilité que l'appareil désigné, incluant ses accessoires attestés conformes d'après la liste des accessoires de la documentation technique du dit-appareil, répond à la directive 98/79/CE sur le diagnostic In-vitro.

Si dichiara nella nostra sola responsabilità, che l'apparecchiatura indicata, comprensiva dei conformi accessori come da elenco della documentazione tecnica di questa apparecchiatura, risponde alle direttive per Diagnostica In-Vitro 98/79/CE.

Geräteart / Type of device / Type d'appareil / Tipo di apparecchio:

**Laborzentrifuge / Laboratory centrifuge / Centrifugeuse de laboratoire / Centrifuga di laboratorio**

Typenbezeichnung / Type designation / Désignation du type / Denominazione del tipo:

**EBA 200 / EBA 200 S**

Das Konformitätsbewertungsverfahren wurde nach Anhang III der Richtlinie 98/79/EG durchgeführt.

The conformity evaluation process was performed in accordance with appendix III of Directive 98/79/EC.

La procédure d'évaluation de la conformité a été réalisée conformément à l'annexe III de la directive 98/79/CE.

La procedura di valutazione di conformità è stata eseguita conformemente all'appendice III delle direttive 98/79/CE.

Angewandte Normen und Richtlinien:

Gemäß Liste der angewandten Normen und mitgeltenden Richtlinien, die Teil der Produktakte ist.

Applied standards and directives:

According to the list of applied standards and valid directives which is part of the product documentation.

Normes et directives appliquées:

Conformément à la liste des normes et directives applicables et appliquées qui font partie du dossier relatif au produit.

Norme e direttive applicate:

Conformemente alla lista delle norme applicate e delle direttive di validità, che sono parte degli atti del prodotto.

Tuttlingen, 2014-07-15



H. Eberle  
Geschäftsführer, Manager,  
Directeur, Gerente



---

## Standards and regulations which apply to this device

The device is a high-end technical product. It is subject to extensive testing and certification procedures according to the following standards and regulations in their respectively valid version:

### Electrical and mechanical safety for design and final testing:

Standard series: IEC 61010 (conform to standards of DIN EN 61010)

- IEC 61010-1 "Safety requirements for electrical equipment for measurement, control, and laboratory use - Part 1: General requirements" (Pollution Degree 2, Installation Category II)
- IEC 61010-2-010 "Safety requirements for electrical equipment for measurement, control and laboratory use - Part 2-010: Particular requirements for laboratory equipment for the heating of materials" (applied to heated centrifuges only)
- IEC 61010-2-020 "Safety requirements for electrical equipment for measurement, control, and laboratory use - Part 2-020: Particular requirements for laboratory centrifuges"
- IEC 61010-2-101 "Safety requirements for electrical equipment for measurement, control and laboratory use - Part 2-101: Particular requirements for in vitro diagnostic (IVD) medical equipment"

### Electromagnetic Compatibility:

- EN 61326-1 "Electrical equipment for measurement, control and laboratory use - EMC requirements - Part 1: General requirements"

### European directives applied for conformity assessment procedures:

- In vitro diagnostic device directive 98/79/EG  
EC conformity assessment procedure according to annex III "EC DECLARATION OF CONFORMITY" – self-declaration by the manufacturer

### Further partly applicable European directives:

- Machinery Directive 2006/42/EC
- EMC directive 2004/108/EC
- Low voltage directive 2006/95/EC

### Applied medical device regulations outside Europe:

- **USA:** QSR, 21CFR 820 "CFR Title 21 - Food and Drugs: TITLE 21- FOOD AND DRUGS, CHAPTER I - FOOD AND DRUG ADMINISTRATION DEPARTMENT OF HEALTH AND HUMAN SERVICES, SUBCHAPTER H - MEDICAL DEVICES, Part 820 QUALITY SYSTEM REGULATIONS"
- **Canada:** CMDR, SOR/98-282 "Medical Devices Regulations"

### Certified quality management system according to

- ISO 9001 "Quality management systems – Requirements"
- ISO13485 "Medical devices - Quality management systems - Requirements for regulatory purposes"

### Environmental management system according to

- ISO 14001 "Environmental management systems - Requirements with guidance for use"

**Contents**

1	How to use these operating instructions .....	42
2	Symbol meanings .....	42
3	Intended use .....	42
4	Remaining risks .....	42
5	Technical specifications .....	43
6	Notes on safety .....	44
7	Transport and storage .....	45
7.1	Transport .....	45
7.2	Storage .....	45
8	Scope of delivery .....	45
9	Removing the transport securing device .....	46
10	Initial operation .....	46
11	Opening and closing the cover .....	47
11.1	Opening the cover .....	47
11.2	Closing the cover .....	47
12	Installation and removal of the rotor .....	48
12.1	EBA 200 .....	48
12.2	EBA 200 S .....	48
13	Loading the rotor .....	49
14	Operating and display elements .....	50
14.1	Displayed symbols .....	50
14.2	Control panel keys .....	50
14.3	Setting options .....	51
15	Entering centrifugation parameters .....	52
15.1	Direct input of the centrifugation parameters .....	52
15.1.1	Speed (RPM) .....	52
15.1.2	Relative centrifugal acceleration (RCF) and centrifugal radius (RAD) .....	52
15.1.3	Runtime .....	52
15.2	Input of the centrifugation parameters with the "SELECT" key .....	53
16	Centrifugation .....	55
16.1	Centrifugation with preset time .....	55
16.2	Continuous run .....	56
16.3	Short-term centrifugation .....	57
17	Emergency Stop .....	57
18	Cycle counter .....	58
18.1	EBA 200 .....	58
18.2	EBA 200 S .....	58

19	Settings and queries .....	58
19.1	Querying system information .....	59
19.2	Acoustic signal .....	60
19.3	Optical signal after ending the centrifugation run .....	61
19.4	Automatic unlocking of the lid after the centrifugation run .....	62
19.5	Backlighting of the display .....	63
19.6	Querying the hours of operation and the number of centrifugation runs .....	64
19.7	Resetting the cycle counter to zero .....	65
20	Relative centrifugal force (RCF) .....	66
21	Centrifugation of materials or mixtures of materials with a density higher than 1.2 kg/dm <sup>3</sup> .....	66
22	Emergency unlocking .....	66
23	Maintenance and servicing .....	67
23.1	Centrifuge (housing, lid and centrifuging chamber) .....	67
23.1.1	Surface cleaning and care .....	67
23.1.2	Surface disinfection .....	67
23.1.3	Removal of radioactive contaminants .....	67
23.2	Rotor and accessories .....	68
23.2.1	Cleaning and care .....	68
23.2.2	Disinfection .....	68
23.2.3	Removal of radioactive contaminants .....	68
23.2.4	Rotors and accessories with limited service lives .....	68
23.3	Autoclaving .....	69
23.4	Centrifuge containers .....	69
24	Faults .....	70
25	Change mains input fuses .....	71
26	Returning Devices .....	71
27	Disposal .....	71
28	Anhang / Appendix .....	136
28.1	Rotoren und Zubehör / Rotors and accessories .....	136

## 1 How to use these operating instructions

- Before using the centrifuge, read the operating instructions and observe them.
- The operating instructions are a part of the device. They must always be kept readily available.
- If the device is set up at a different location, the operating instructions must be provided with it.

## 2 Symbol meanings



Symbol on the device:

Attention, general hazard area.

Before using the device, make sure you read the operating instructions and observe the safety information!



Symbol in this document:

Attention, general hazard area.

This symbol refers to safety relevant warnings and indicates possibly dangerous situations.

The non-adherence to these warnings can lead to material damage and injury to personal.



Symbol on the device and in this document:

Beware of biohazard.



Symbol in this document:

This symbol refers to important circumstances.



Symbol on the device and in this document:

Symbol for the separate collection of electric and electronic devices according to the guideline 2002/96/EG (WEEE). The device belongs to Group 8 (medical devices).

Applies in the countries of the European Union, as well as in Norway and Switzerland.

## 3 Intended use

This device is a medical product (laboratory centrifuge) within the context of the IVD Directive 98/79/EC.

The centrifuge was designed only for the separation of substances or mixtures with a density of no more than 1.2 kg/dm<sup>3</sup>, particularly of samples for preparation for human medical in-vitro diagnostics.

This especially includes the determination of potassium in blood serum. The running behaviour allows for gentle separation, thereby preventing the accumulation of additional erythrocytic potassium in the serum. This prevents the test results from being falsified.

The centrifuge is only meant for this purpose.

Another use or one which goes beyond this, is considered to be non-intended. The company Andreas Hettich GmbH & Co. KG is not liable for damage resulting from this.

Observing all information in the operating instructions and complying with the measures described therein is also a part of the intended use.

If the centrifuge is installed in another device or in a system, the manufacturer of the overall system is responsible for its safety.

## 4 Remaining risks

The device is built according to the state-of-the-art and the recognized safety regulations. If used and handled improperly, there could be life-threatening danger to the user or third parties, or the device could be impaired or there could be other property damage. The device is only to be used for its intended purpose and only when it is in safe working condition.

Malfunctions which could affect safety must be corrected immediately.

## 5 Technical specifications

Manufacturer	Andreas Hettich GmbH & Co. KG D-78532 Tuttlingen			
Model	EBA 200		EBA 200 S	
Type	1800	1800-01	1802	1802-01
Mains voltage ( $\pm 10\%$ )	200 - 240 V 1~	100 - 127 V 1~	200 - 240 V 1~	100 - 127 V 1~
Mains frequency	50 - 60 Hz-	50 - 60 Hz	50 - 60 Hz-	50 - 60 Hz
Connected load	100 VA	100 VA	160 VA	160 VA
Current consumption	0.5 A	1.0 A	0.75 A	1.5 A
Max. capacity	8 x 15 ml			
Allowed density	1.2 kg/dm <sup>3</sup>			
Speed (RPM)	6000		8000	
Force (RCF)	3461		6153	
Kinetic energy	750 Nm		1750 Nm	
Obligatory inspection (BGR 500)	no			
Ambient conditions (EN / IEC 61010-1)	Indoors only Up to 2000 m above sea level 2°C to 40°C Maximum relative humidity 80% for temperatures up to 31°C, linearly decreasing to 50% relative humidity at 40°C.			
– Set-up site				
– Altitude				
– Ambient temperature				
– Humidity				
– Excess-voltage category (IEC 60364-4-443)	II			
– Pollution degree	2			
Device protection class	I			
Not suitable for use in explosion-endangered areas.				
EMC	EN / IEC 61326-1, Class B		EN / IEC 61326-1, Class B	
– Emitted interference, Interference immunity	FCC Class B		FCC Class B	
Noise level (dependent on rotor)	$\leq 50$ dB(A)		$\leq 55$ dB(A)	
Dimensions				
– Width	261 mm			
– Depth	353 mm			
– Height	228 mm			
Weight	approx. 9 kg		approx. 10 kg	



## 6 Notes on safety



No claim of warranty will be considered by the manufacturer unless ALL instructions in this manual have been followed.



- The centrifuge should be installed on a good, stable base.
- Before using the centrifuge absolutely check the rotor for firm placement.
- When the centrifuge is running, according to EN / IEC 61010-2-020, no persons, dangerous substances or objects may be within the safety margin of 300 mm around the centrifuge.
- Rotors, suspensions and accessories that possess traces of corrosion or mechanical damage or if their term of use has expired may not be used any longer.
- The centrifuge may no longer be put into operation when the centrifuging chamber has safety-related damages.
- For centrifuges without temperature control, when the room temperature is increased and/or if the device is frequently used, the centrifuging chamber could be heated up. Therefore, it can't be ruled out that the sample material might be changed due to the temperature.

- Before the initial operation of your centrifuge you should read and pay attention to the operating instructions. Only personnel that has read and understood the operating instructions are allowed to operate the device.
- Along with the operating instructions and the legal regulations on accident prevention, you should also follow the recognised professional regulations for working in a safe and professional manner. These operating instructions should be read in conjunction with any other instructions concerning accident prevention and environmental protection based on the national regulations of the country where the device is to be used.
- This centrifuge is a state-of-the-art piece of equipment which is extremely safe to operate. However, it can lead to danger for users or others if used by untrained staff, in an inappropriate way or for a purpose other than that it was designed for.
- The centrifuge must not be moved or knocked during operation.
- In case of fault or emergency release, never touch the rotor before it has stopped turning.
- To avoid damage due to condensate, when changing from a cold to a warm room the centrifuge must either heat up for at least 3 hours in the warm room before being connected to the mains, or run hot for 30 minutes in the cold room.
- Only the rotor approved by the manufacturer for this device and the approved accessories may be used (see chapter "Anhang/Appendix, Rotoren und Zubehör/Rotors and accessories"). Before centrifuge vessels are used which are not listed in the chapter "Appendix, Rotors and accessories", the user must make sure they can be used by asking the manufacturer.
- The centrifuge rotor may only be loaded in accordance with the chapter "Loading the rotor".
- When centrifuging with maxim revolutions per minute the density of the materials or the material mixtures may not exceed 1.2 kg/dm<sup>3</sup>.
- The centrifuge may only be operated when the balance is within the bounds of acceptability.
- The centrifuge may not be operated in explosion-endangered areas.
- The centrifuge must not be used with:
  - inflammable or explosive materials
  - materials that react with one another producing a lot of energy.
- If users have to centrifuge hazardous materials or compounds contaminated with toxic, radioactive or pathogenic micro-organisms, they must take appropriate measures.  
For hazardous substances centrifuge containers with special screw caps must strictly be used. In addition to the screw cap centrifuge containers, for materials in hazard category 3 and 4 a biosafety system must be used (see the World Health Organisation's "Laboratory Biosafety Manual").  
Without the use of a biosafety system the centrifuge is not microbiologically sealed in the sense of the EN / IEC 610101-2-020 standard.  
No biosafety systems are available for this centrifuge.

- The centrifuge must not be operated with highly corrosive substances which could impair the mechanical integrity of rotors, hangers and accessories.
- Repairs must only be carried out by personnel authorised to do so by the manufacturer.
- Only original spare parts and original accessories licensed by the Andreas Hettich GmbH & Co. KG company are allowed to be utilised.
- The following safety regulations apply:  
EN / IEC 61010-1 and EN / IEC 61010-2-020 as well as their national deviations.
- The safe operation and reliability of the centrifuge can only be guaranteed if:
  - the centrifuge is operated in accordance with the operating instructions,
  - the electrical installation on the site where the centrifuge is installed conforms to the demands of EN / IEC stipulations,
  - the tests for device safety required in the respective countries, e.g. in Germany in acc. with BGV A1 and BGR 500, are carried out by an expert.

## 7 Transport and storage

### 7.1 Transport



Before transporting the device, the transport securing device must be installed.

When the device and accessories are transported, the following ambient conditions must be complied with:

- Ambient temperature: -20°C to +60°C
- Relative humidity: 20% to 80%, non-condensing

### 7.2 Storage



The device and the accessories may only be stored in closed and dry rooms.

When the device and accessories are stored, the following ambient conditions must be complied with:

- Ambient temperature: -20°C to +60°C
- Relative humidity: 20% to 80%, non-condensing

## 8 Scope of delivery

The following accessories are delivered with the centrifuge:

- 1 connecting cable
- 2 fuses
- 8 reducers, 1059 (EBA 200 S only)
- 1 hex head wrench
- 1 copy of operating instructions
- 1 information sheet, transport securing device
- 1 information sheet, emergency unlocking

The centrifuge is delivered complete with an angle rotor (8x15 ml).

## 9 Removing the transport securing device



It is imperative that the transport securing device be removed.

Keep the transport securing device in a safe place since it must be installed again before transporting the device.

The device may only be transported with the transport securing device installed.

To protect the device from damage during transport, the motor is fixed in place.  
This transport securing device must be removed when the device is put into operation.

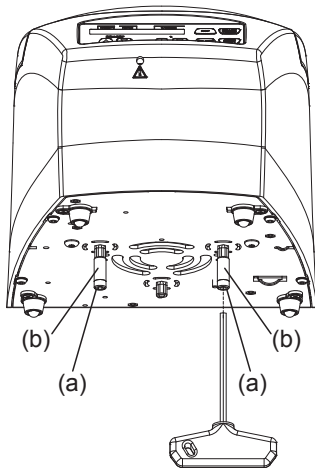

- Remove the two screws (a) and spacer sleeves (b).



The transport securing device is installed in the opposite order.

## 10 Initial operation

- Remove the transport securing device from the housing floor; see the "Removing the transport securing device" chapter.
- **Position the centrifuge in a stable and level manner in a suitable place. During set-up, the required safety margin of 300 mm around the centrifuge is to be kept according to EN / IEC 61010-2-020.**



**When the centrifuge is running, according to EN / IEC 61010-2-020, no persons, dangerous substances or objects may be within the safety margin of 300 mm around the centrifuge.**

- Do not place any object in front of the ventiduct.  
Keep a ventilation area of 300 mm around the ventiduct.
- Check whether the mains voltage tallies with the statement on the type plate.
- Connect the centrifuge with the connection cable to a standard mains socket. For connection ratings refer to Chapter "Technical specifications".
- Switch on the mains switch (switch position "I").  
The following displays appear one after the other:
  1. The centrifuge model
  2. The type number and program version
  3. The last used centrifuging data



If the cover is closed, it opens automatically.

## 11 Opening and closing the cover

### 11.1 Opening the cover



The cover can only be opened if the centrifuge is switched on and the rotor is stationary. If this shouldn't be possible, see the "Emergency unlock" chapter.



When the cycle counter is activated, after a centrifugation run, while opening the cover, the remaining number of running cycles (centrifugation runs) is briefly displayed.

Example:



- Press the key.  
The cover is unlocked by the motor.  
🔓 : Cover unlocked.

Example:



### 11.2 Closing the cover



Do not reach with your fingers between the cover and housing.  
Do not slam the cover closed.

- Put the cover on and lightly press the front edge of the cover down.  
The cover is locked by the motor.  
🔒 : Cover locked.

Example:



## 12 Installation and removal of the rotor

### 12.1 EBA 200

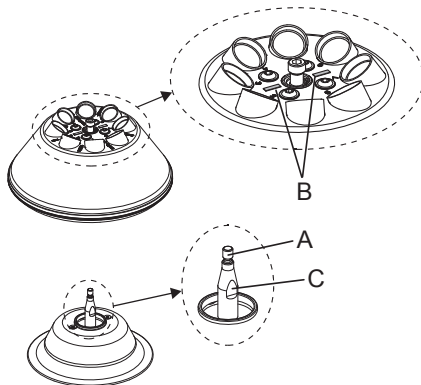

#### Installation:

- Clean the motor shaft (A) and the bore of the rotor and then apply a thin coat of grease to the motor shaft. Dirt particles between the motor shaft and rotor prevent the rotor from having a perfect seat and cause it to run unsteadily.
- Place the rotor vertically onto the motor shaft. When putting on the rotor, the marking beam (B) on the rotor must be parallel to both surfaces (C) on the motor shaft.
- Tighten the clamping nut of the rotor with the Allen wrench (included in delivery) by turning clockwise.
- Check the rotor to make sure it is seated firmly.

#### Removal:

- Loosen the rotor's clamping nut by turning counter-clockwise with the Allen wrench (included in delivery) and turn up to the lifting pressure point. After overcoming the lifting pressure point, the rotor is released from the cone of the motor shaft. Turn the clamping nut until the rotor can be lifted up from the motor shaft.
- Lift up the rotor from the motor shaft.

### 12.2 EBA 200 S



The rotor may only be installed and removed by Customer Service.

### 13 Loading the rotor



Standard centrifuge containers of glass will not stand RCF values exceeding 4000 (DIN 58970, pg. 2).

- Check the rotor for firm seating.
- The rotors must be loaded symmetrically. The centrifuge containers have to be distributed evenly on all rotor positions. For authorised combinations see Chapter "Anhang/Appendix, Rotoren und Zubehör/Rotors and accessories".

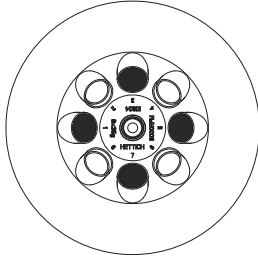

Rotor is evenly loaded

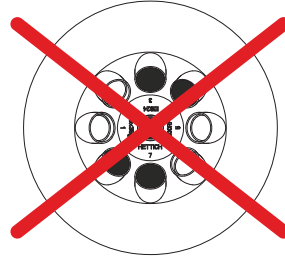

**Not permitted!**

Rotor is not evenly loaded

- The centrifuge containers may only be filled outside of the centrifuge.
- The maximum filling quantity for the centrifuge containers specified by the manufacturer must not be exceeded. The centrifuging vessels may only be filled so far that no fluid can be expelled from them while the centrifuge is running.

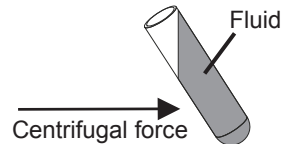

- When loading the rotor, no liquid may enter the rotor or the centrifuging chamber.
- In order to maintain the weight differences within the centrifuge container as marginal as possible, a consistent fill level in the containers is to be heeded.
- The weight of the permissible filling quantity is specified on each rotor. This weight may not be exceeded.

## 14 Operating and display elements

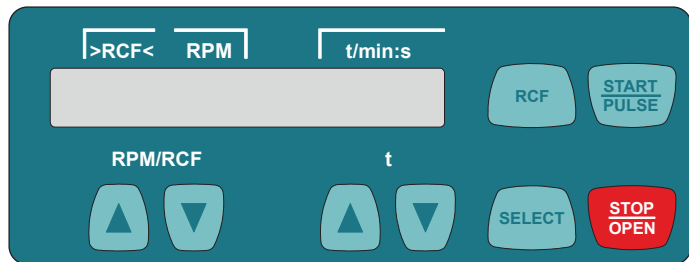

### 14.1 Displayed symbols



Lid unlocked.



Lid locked.



Rotation display. The rotation display lights up, rotating counterclockwise, as long as the rotor is turning.

### 14.2 Control panel keys

#### RPM/RCF



- Input the speed directly.
- If the key is kept pressed, the value changes with increasing speed.

#### t



- Input the runtime directly.
- Adjustable in steps of 1 second up to a minute, and in steps of 1 minute starting from 1 minute.
- Input the centrifuging parameters.
- If the key is kept pressed, the value changes with increasing speed.



- Selection key for activating the individual parameters.
- Every time the key is pressed, the next parameter is activated.



- Switching between the RPM display (RPM) and RCF display (>RCF<). RCF values are displayed in parentheses ><.
- RPM Speed
- RCF : Relative centrifugal acceleration



- Start the centrifugation run.
- Short-term centrifugation.
- Centrifugation is run as long as the key is kept pressed.



- Finish the centrifugation run.
- The rotor runs down with a pre-selected brake stage.
- Pressing the key twice triggers the Emergency Stop.
- Unlock the lid.

### 14.3 Setting options

**t/min**     **Runtime.** Adjustable from 1 - 99 min, in steps of 1 minute.

**t/sec**     **Runtime.** Adjustable from 1 - 59 s, in steps of 1 second.

**Continuous run "--:--".** Set the parameters **t/min** and **t/sec** to zero.

**RPM**     **Speed**

A number value from 200 rpm to the maximum speed of the rotor can be set.  
Settable in increments of 10.

For the maximum rotor speed, see the chapter "Appendix, Rotors and accessories".

**>RCF<**     **Relative centrifugal acceleration**

A number value can be set which results in a speed between 200 rpm and the maximum rotor speed.  
Settable in increments of 1.



It is only possible to input the relative centrifugal acceleration (RCF) if the RCF display (>RCF<) is activated.

The relative centrifugal acceleration (RCF) depends on the centrifuging radius (RAD). After entering the RCF, check to make sure that the correct centrifuging radius has been set.

**RAD/mm**     **Centrifuging radius**

Adjustable from 10 mm to 250 mm, in steps of 1 mm.

For the centrifuging radius, see the chapter "Appendix, Rotors and accessories".





It is only possible to input the centrifuging radius if the RCF display (>RCF<) is activated.

**~\_DEC**     **Brake stage.** **fast** = short run-out time, **slow** = long run-out time.



## 15 Entering centrifugation parameters

### 15.1 Direct input of the centrifugation parameters

The speed (RPM), the relative centrifugal acceleration (RCF), the centrifuging radius (RAD) and the runtime can be input directly with the keys   without previously having to press the  key.

 The set centrifugation parameters are only stored after starting the centrifugation run.

#### 15.1.1 Speed (RPM)

Example:



- Press the key to activate the RPM display (RPM) as needed.

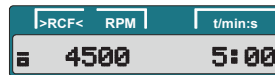

RPM/RCF



- Set the desired value with the keys.

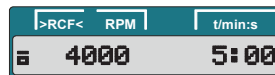

#### 15.1.2 Relative centrifugal acceleration (RCF) and centrifugal radius (RAD)

Example:



- Press the key to activate the RCF display (>RCF<) as needed.

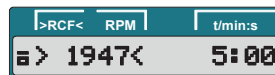

RPM/RCF



- Set the desired RCF value with the keys.



- Set the desired centrifuging radius with the keys as needed.

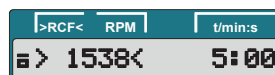

#### 15.1.3 Runtime

 Up to 1 minute, the runtime can be set in steps of 1 second, and starting from 1 minute, it can only be set in steps of 1 minute.

In order to set the continuous run, the parameters **t/min** and **t/sec** must be set to zero. In the time display (t/min:s), "--:--" appears.

Example:

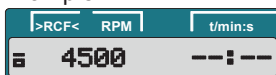

Example:



- Set the desired value with the keys.

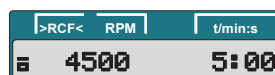

## 15.2 Input of the centrifugation parameters with the "SELECT" key



The runtime can be set in minutes and seconds (parameters **t/min** and **t/sec**).

In order to set the continuous run, the parameters **t/min** and **t/sec** must be set to zero. In the time display (t/min:s), "--:--" appears.

Example:

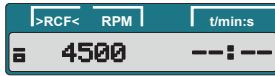

The relative centrifugal acceleration (RCF) depends on the centrifuging radius (RAD). After entering the RCF, check to make sure that the correct centrifuging radius has been set.



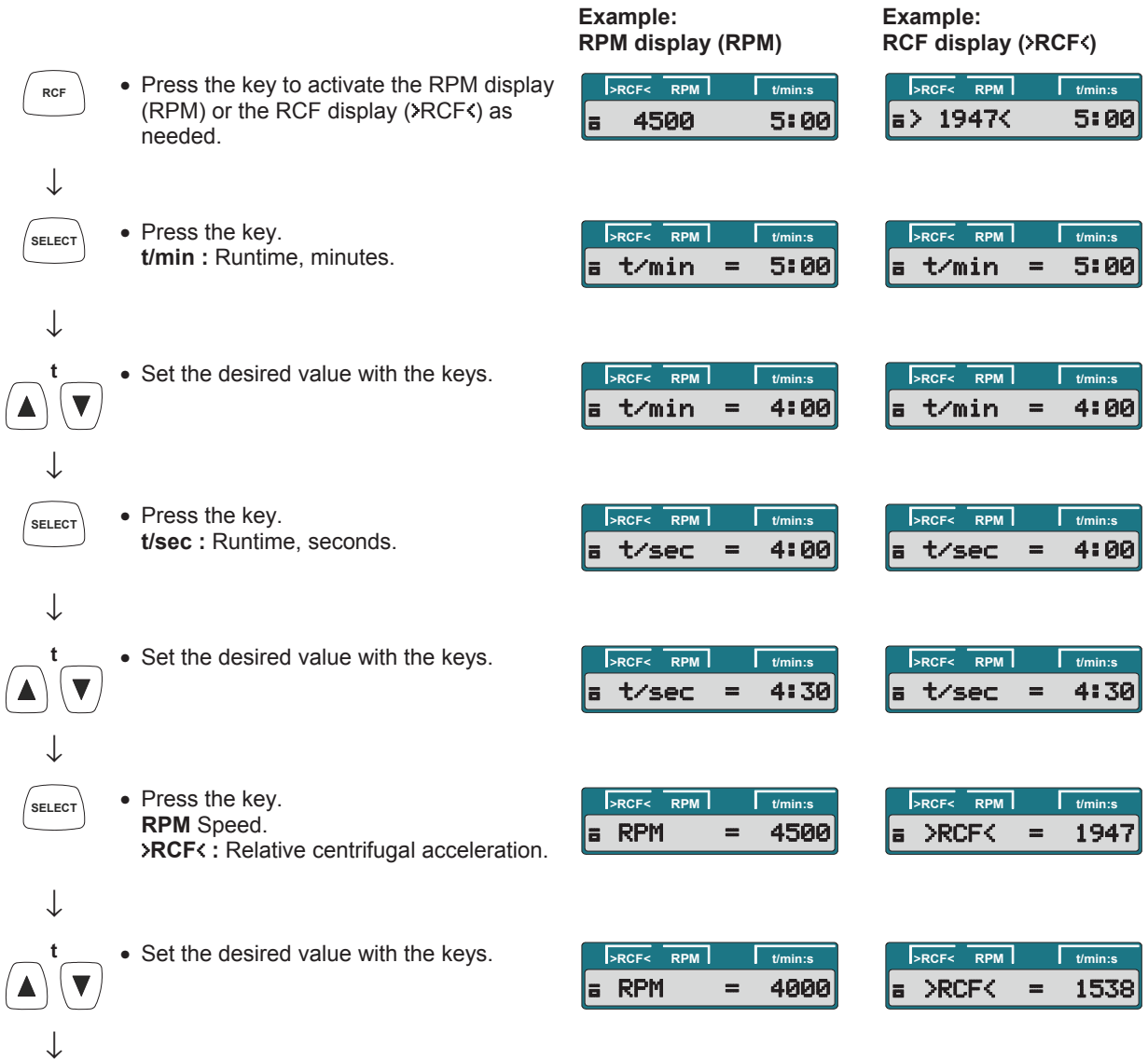

If no key is pressed for 8 seconds after selection or during parameter input, the previous values are shown on the display. The parameters must then be input again.

If several parameters are input, the  key must be pressed after setting the last parameter.

Entering parameters can be cancelled at any time by pressing the  key. In this case, the settings are not stored.

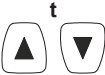

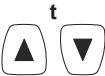
Continued on next page

- 
  - Press the key.  
**RAD/mm** : Centrifuging radius.  
 It is only possible to display and input the centrifuging radius if the RCF display (>RCF<) is activated.
- ↓
- 
  - Set the desired value with the keys.
- ↓
- 
  - Press the key.  
**\\_DEC** : Brake stage.  
**fast** : short run-out time.  
**slow** : long run-out time.
- ↓
- 
  - Set the desired value with the keys.
- ↓
- 
  - Press the button to save the setting.

**Example:  
RPM display (RPM)**

**Example:  
RCF display (>RCF<)**

	>RCF< RPM t/min:s	>RCF< RPM t/min:s
	▣ RAD/mm = 86	▣ RAD/mm = 86
	▣ RAD/mm = 67	▣ RAD/mm = 67
	▣ \_DEC = slow	▣ \_DEC = slow
	▣ \_DEC = fast	▣ \_DEC = fast
	▣ 4000 4:30	▣ > 1538< 4:30

## 16 Centrifugation

 In accordance with EN / IEC 61010-2-020, no persons, hazardous substances or objects may be within a safety range 300 mm around the centrifuge during a centrifugation run.

 After each centrifugation run, while the lid is unlocking, the remaining number of running cycles (centrifugation runs) will be briefly displayed (only on the EBA 200).

Example:



If the permissible weight difference was exceeded within the rotor load, the centrifugation run is aborted during start-up and the following will appear on the display:



A centrifugation run can be aborted at any time by pressing the  key.

During a centrifugation run, centrifugation parameters can be selected and changed. The changed values, however, only apply to the current centrifugation run and are not saved.

With the  key, you can toggle between the RPM display (RPM) and RCF display (>RCF<) at any time. If the RCF display (>RCF<) is worked with, the centrifuging radius must be input.

The following is displayed:



Further operation of the centrifuge is then only possible after opening the lid.

Operation errors and malfunctions will be shown (see the chapter on "Malfunctions").

- Plug in the mains switch. Switch position I.
- Load the rotor and close the centrifuge lid.

### 16.1 Centrifugation with preset time



- Press the key to activate the RPM display (RPM) or the RCF display (>RCF<) as needed.



- Enter the desired centrifugation parameters (see the chapter "Entering centrifugation parameters").



- Press the key to start the centrifugation run.  
During the centrifugation run, the rotor speed or the resulting RCF value and remaining time are displayed.



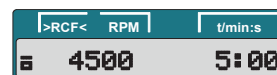

Continued on next page

Example:  
RPM display (RPM)

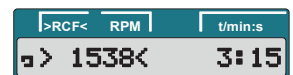
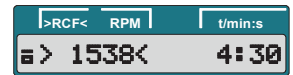
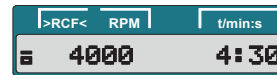

Example:  
RCF display (>RCF<)



- After the time elapses or if the centrifugation run is aborted by pressing the  key, the run-out occurs with the set brake stage. The brake stage is displayed. Example 

Example:  
RPM display (RPM)

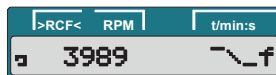

Example:  
RCF display (>RCF<)



## 16.2 Continuous run



- Press the key to activate the RPM display (RPM) or the RCF display (>RCF<) as needed.



- Input the desired centrifugation parameters. Set the parameters **t/min** and **t/sec** to zero (see the chapter "Entering centrifugation parameters").



- Press the key to start the centrifugation run. During the centrifugation, the rotor speed or the resulting RCF value and elapsed time are displayed.



- Press the key to end the centrifugation run. The run-out occurs with the set brake stage. The brake stage is displayed. Example 

Example:  
RPM display (RPM)



Example:  
RCF display (>RCF<)

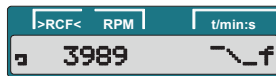
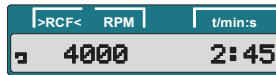
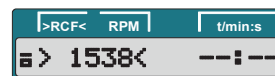
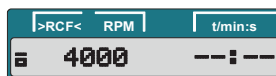

### 16.3 Short-term centrifugation



- Press the key to activate the RPM display (RPM) or the RCF display (>RCF<) as needed.



- Enter the desired centrifugation parameters (see the chapter "Entering centrifugation parameters").



- Press the key and keep it pressed.  
During the centrifugation run, the rotor speed or the resulting RCF value and elapsed time are displayed.



- Release the key again to end the centrifugation run.  
The run-out occurs with the set brake stage. The brake stage is displayed. Example ~\\_f.

Example:  
RPM display (RPM)

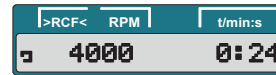

Example:  
RCF display (>RCF<)

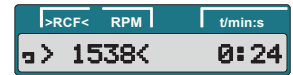

### 17 Emergency Stop



- Press the key twice.  
During the Emergency Stop, the run-out occurs with the "fast" brake stage (short run-out time). Brake stage ~\\_f is displayed.

Example:  
RPM display (RPM)



Example:  
RCF display (>RCF<)

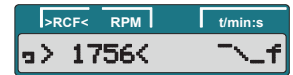

## 18 Cycle counter

### 18.1 EBA 200

 The period of use of the rotor is limited to 50000 running cycles (centrifugation runs).

The centrifuge is equipped with a cycle counter, which counts the running cycles (centrifugation runs).

After each centrifugation run, while the lid is unlocking, the remaining number of running cycles (centrifugation runs) will be briefly displayed.

Example:

```
>RCF< RPM | t/min:s
RemCycles= 16703
```

If the maximum permissible number of rotor running cycles has been exceeded, the following is displayed every time the centrifugation run is started and the centrifugation run must be restarted.

```
>RCF< RPM | t/min:s
Cycles Passed
```

 The following is displayed:

```
>RCF< RPM | t/min:s
Cycles Passed
```

the rotor must be immediately exchanged for a new rotor for safety reasons.

After the rotor has been exchanged, the cycle counter must be reset to "0" (see chapter "Resetting the cycle counter to '0'").

### 18.2 EBA 200 S

 The period of use of the rotor is not limited. For this reason, the cycle counter is not required and is therefore switched off.

## 19 Settings and queries

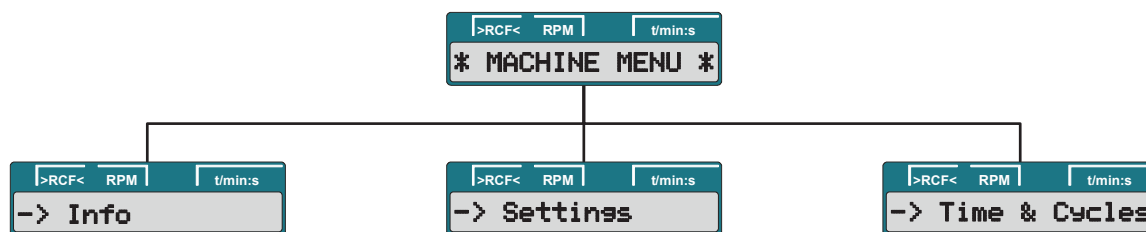

#### Query:

- System information

#### Setting:

- Acoustic signal
- Automatic unlocking of the lid after the centrifugation run
- Automatic switch-off of the background lighting
- Optical signal after ending the centrifugation run

#### Query:

- Hours of operation
- Number of completed centrifugation runs

#### Setting:



- Cycle counter

### 19.1 Querying system information

The following system information can be queried:

- Centrifuge model
- Centrifuge program version
- Frequency converter type
- Frequency converter program version

With the rotor at a standstill, the query can proceed as follows:

 The procedure can be aborted at any time by pressing the  key.



- Press and hold the button for eight seconds.



- Press the key.



- Press the key.  
Centrifuge model.

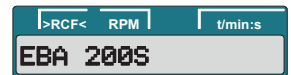
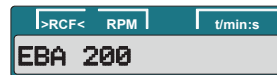

- Press the key.  
Centrifuge program version.

Example:



- Press the key.  
Frequency converter type.

Example:



- Press the key.  
Frequency converter program version.

Example:



- Press the key twice to exit the "-> Info" menu or press three times to exit the "\* MACHINE MENU \*".



Example:







## 19.2 Acoustic signal

The acoustic signal sounds:

- after a malfunction occurs in a 2-second interval.
- after ending the centrifugation run and the rotor is at a standstill in a 30-second interval.

The acoustic signal is ended by pressing any key.

If the rotor is at a standstill, the acoustic signal can be set as follows:

 The procedure can be aborted at any time by pressing the  key. In this case, the settings are not stored.

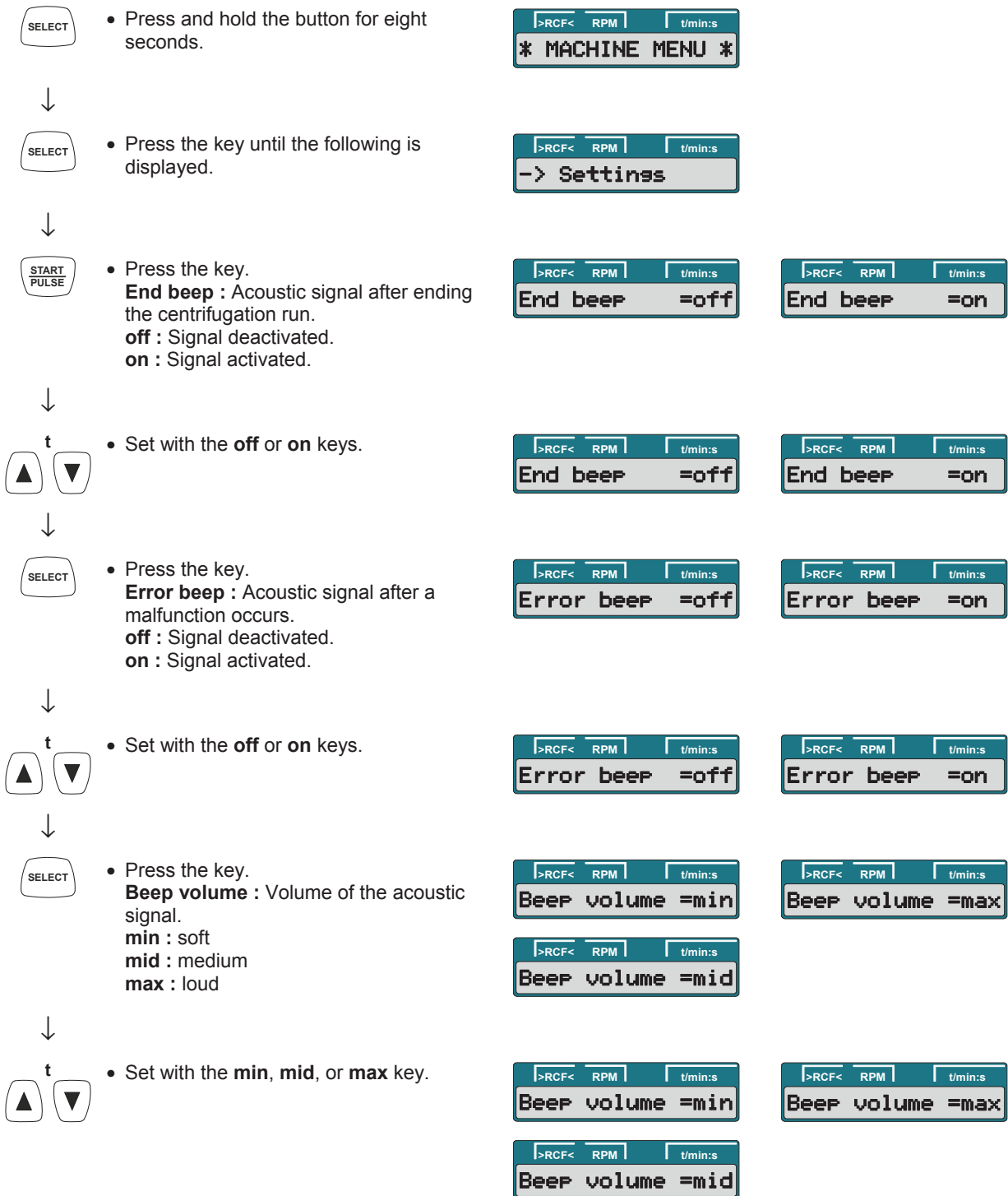

Continued on next page

 • Press the button to save the setting.



 • Press the key once to exit the "-> Settings" menu or press twice to exit the "\* MACHINE MENU \*".





Example:



### 19.3 Optical signal after ending the centrifugation run

The backlighting of the display flashes after the centrifugation run to visually signalize that the centrifugation run has finished.

The optical signal can be switched on or off when the rotor is at a standstill:

 The procedure can be aborted at any time by pressing the  key.

 • Press and hold the button for eight seconds.



 • Press the key until the following is displayed.



 • Press the key.



 • Press the key until one of the following is displayed:  
**End blinking** : Backlighting of display flashes after the centrifugation run.  
**off** : Backlighting does not flash.  
**on** : Backlighting flashes.



 • Set with the **off** or **on** keys.



 • Press the button to save the setting.



 • Press the key once to exit the "-> Settings" menu or press twice to exit the "\* MACHINE MENU \*".



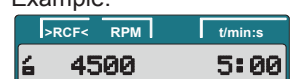

Example:













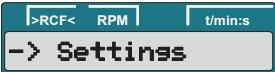

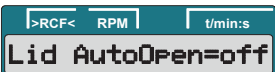

### 19.4 Automatic unlocking of the lid after the centrifugation run

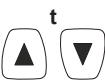
It can be set whether the lid should automatically unlock or not after the centrifugation run.

With the rotor at a standstill, this can be set as follows:

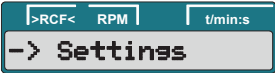

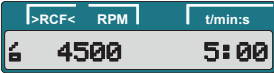
 The procedure can be aborted at any time by pressing the  key. In this case, the settings are not stored.

















	<ul style="list-style-type: none"> <li>Press and hold the button for eight seconds.</li> </ul>		
	<ul style="list-style-type: none"> <li>Press the key until the following is displayed.</li> </ul>		
	<ul style="list-style-type: none"> <li>Press the key.</li> </ul>		
	<ul style="list-style-type: none"> <li>Press the key until one of the following is displayed:  <b>Lid AutoOpen</b> : Automatic unlocking of the lid after the centrifugation run.  <b>off</b> : Lid does not unlock automatically.  <b>on</b> : Lid unlocks automatically.</li> </ul>		
	<ul style="list-style-type: none"> <li>Set with the <b>off</b> or <b>on</b> keys.</li> </ul>		
	<ul style="list-style-type: none"> <li>Press the button to save the setting.</li> </ul>		
	<ul style="list-style-type: none"> <li>Press the key once to exit the "-&gt; Settings" menu or press twice to exit the "* MACHINE MENU *".</li> </ul>		<p>Example:</p> 

### 19.5 Backlighting of the display

To save energy, it can be set that, after a centrifugation run, the backlighting of the display switches off after 2 minutes.

With the rotor at a standstill, this can be set as follows:

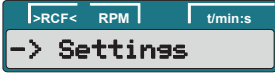
 The procedure can be aborted at any time by pressing the  key. In this case, the settings are not stored.

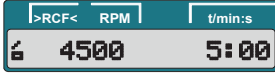
	<ul style="list-style-type: none"> <li>Press and hold the button for eight seconds.</li> </ul>		
↓			
	<ul style="list-style-type: none"> <li>Press the key until the following is displayed.</li> </ul>		
↓			
	<ul style="list-style-type: none"> <li>Press the key.</li> </ul>		
↓			
	<ul style="list-style-type: none"> <li>Press the key until one of the following is displayed:  <b>Power save</b> : Automatic shutdown of the backlighting.  <b>off</b> : Automatic shutdown deactivated.  <b>on</b> : Automatic shutdown activated.</li> </ul>		
↓			
	<ul style="list-style-type: none"> <li>Set with the <b>off</b> or <b>on</b> keys.</li> </ul>		
↓			
	<ul style="list-style-type: none"> <li>Press the button to save the setting.</li> </ul>		
↓			
	<ul style="list-style-type: none"> <li>Press the key once to exit the "-&gt; Settings" menu or press twice to exit the "* MACHINE MENU *".</li> </ul>		<p>Example:</p> 

### 19.6 Querying the hours of operation and the number of centrifugation runs

The hours of operation are divided into internal and external hours of operation.

Internal hours of operation: Total time the device was switched on.

External hours of operation: Total time of the previous centrifugation runs.

With the rotor at a standstill, the query can proceed as follows:

 The procedure can be aborted at any time by pressing the  key.



- Press and hold the button for eight seconds.



- Press the key until the following is displayed.



- Press the key.  
**TimeExt** : External hours of operation.

Example:



- Press the key.  
**TimeInt** : Internal hours of operation.

Example:



- Press the key.  
**Starts** : Number of all centrifugation runs.

Example:



- Press the key twice to exit the "-> Time & Cycles" menu or press three times to exit the "\* MACHINE MENU \*".

Example:



### 19.7 Resetting the cycle counter to zero

After the rotor has been exchanged, the cycle counter must be reset to zero again.



The cycle counter may only be reset to zero if the rotor has been exchanged for a new rotor first.

With the rotor at a standstill, the cycle counter can be reset as follows:



The procedure can be aborted at any time by pressing the  key. In this case, the settings are not stored.



- Press and hold the button for eight seconds.

>RCF<	RPM	t/min:s
* MACHINE MENU *		

↓



- Press the key until the following is displayed.

>RCF<	RPM	t/min:s
-> Time & Cycles		

↓



- Press the key.

Example:

>RCF<	RPM	t/min:s
TimeExt=		43 h

↓



- Press the key until the following is displayed:  
**Cyc sum** : Number of completed run cycles.

>RCF<	RPM	t/min:s
Cyc sum=		50001

↓



- Press the key.

>RCF<	RPM	t/min:s
Cyc sum=<		50001>

↓



- Press the key.  
The number of completed run cycles is reset to zero.

>RCF<	RPM	t/min:s
Cyc sum=<		0>

↓



- Press the button to save the setting.

>RCF<	RPM	t/min:s
Store cycles ...		

>RCF<	RPM	t/min:s
Cyc sum=		0

↓



- Press the key twice to exit the "-> Time & Cycles" menu or press three times to exit the "\* MACHINE MENU \*".

>RCF<	RPM	t/min:s
* MACHINE MENU *		

Example:

>RCF<	RPM	t/min:s
6	4500	5:00

## 20 Relative centrifugal force (RCF)

The relative centrifugal force (RCF) is given as a multiple of the acceleration of gravity (g). It is a unit-free value and serves to compare the separation and sedimentation performance.

These values are calculated using the formula below:

$$\text{RCF} = \left( \frac{\text{RPM}}{1000} \right)^2 \times r \times 1,118 \quad \Rightarrow \quad \text{RPM} = \sqrt{\frac{\text{RCF}}{r \times 1,118}} \times 1000$$

RCF = relative centrifugal force

RPM = rotational speed (revolutions per minute)

r = centrifugal radius in mm = distance from the centre of the turning axis to the bottom of the centrifuge.

For more on the centrifugal radius see the chapter "Anhang/Appendix, Rotoren und Zubehör/Rotors and accessories".



The relative centrifugal force (RCF) stands in relation to the revolutions per minute and the centrifugal radius.

## 21 Centrifugation of materials or mixtures of materials with a density higher than 1.2 kg/dm<sup>3</sup>

When centrifuging with maximum revolutions per minute the density of the materials or the material mixtures may not exceed 1.2 kg/dm<sup>3</sup>.

The speed must be reduced for materials or mixtures of materials with a higher density.

The permissible speed can be calculated using the following formula:

$$\text{Reduced speed (n}_{\text{red}}) = \sqrt{\frac{1.2}{\text{Greater density [kg/dm}^3]}} \times \text{maximum speed [RPM]}$$

e.g.: maximum speed RPM 4000, density 1.6 kg/dm<sup>3</sup>

$$n_{\text{red}} = \sqrt{\frac{1.2 \text{ kg/dm}^3}{1.6 \text{ kg/dm}^3}} \times 4000 \text{ RPM} = 3464 \text{ RPM}$$

If in doubt you should obtain clarification from the manufacturer.

## 22 Emergency unlocking

In the event of a power failure, the lid cannot be unlocked with the motor. Emergency unlocking must be done by hand.



To unlock in an emergency, disconnect the centrifuge from the mains.  
Open the lid only when the rotor is at a standstill.



CAUTION! Damage to the lock during emergency unlocking by turning the hexagon Allen key in clockwise direction (to the right).

The Allen key may only be turned counter clockwise (to the left); see figure.

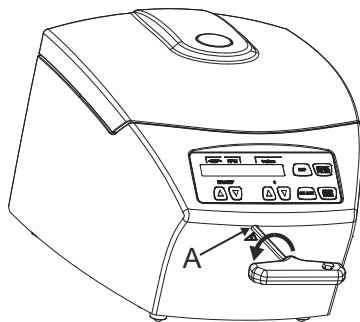

- Switch of the mains switch (switch setting "0").
- Look through the window in the lid to make sure that the rotor is at a standstill.
- Insert the Allen key horizontally in the bore (A) and turn carefully counter clockwise (to the left) until the lid opens.
- Pull the Allen key back out of the bore.

## 23 Maintenance and servicing



The device can be contaminated.



Pull the mains plug before cleaning.

Before any other cleaning or decontamination process other than that recommended by the manufacturer is applied, the user has to check with the manufacturer that the planned process does not damage the device.

- Centrifuges, rotors and accessories must not be cleaned in rinsing machines.
- They may only be cleaned by hand and disinfected with liquids.
- The water temperature must be between 20 – 25°C.
- Only detergents/disinfectants may be used which:
  - have a pH between 5 - 8
  - do not contain caustic alkalis, peroxides, chlorine compounds, acids and alkaline solutions
- In order to prevent appearances of corrosion through cleaning agents or disinfectants, the application guide from the manufacturer of the cleaning agent or disinfectant are absolutely to be heeded.

### 23.1 Centrifuge (housing, lid and centrifuging chamber)

#### 23.1.1 Surface cleaning and care

- Clean the centrifuge housing and the centrifuging chamber regularly, using soap or a mild detergent and a damp cloth if required. For one thing, this services purposes of hygiene, and it also prevents corrosion through adhering impurities.
- Ingredients of suitable detergents: soap, anionic tensides, non-ionic tensides.
- After using detergents, remove the detergent residue by wiping with a damp cloth.
- The surfaces must be dried immediately after cleaning.
- In the event of condensation water formation, dry the centrifugal chamber by wiping out with an absorbent cloth.
- Lightly rub the rubber seal of the centrifuge chamber with talcum powder or a rubber care product after each cleaning.
- The centrifuging chamber is to be checked for damage once a year.



If damage is found which is relevant to safety, the centrifuge may no longer be put into operation. In this case, notify Customer Service.

#### 23.1.2 Surface disinfection

- If infectious materials penetrates into the centrifugal chamber this is to be disinfected immediately.
- Ingredients of suitable disinfectants: ethanol, n-propanol, ethyl hexanol, anionic tensides, corrosion inhibitors.
- After using disinfectants, remove the disinfectant residue by wiping with a damp cloth.
- The surfaces must be dried immediately after disinfecting.

#### 23.1.3 Removal of radioactive contaminants

- The agent must be specifically labelled as being an agent for removing radioactive contaminants.
- Ingredients of suitable agents for removing radioactive contaminants: anionic tensides, non-ionic tensides, polyhydrated ethanol.
- After removing the radioactive contaminants, remove the agent residue by wiping with a damp cloth.
- The surfaces must be dried directly after removing the radioactive contaminants.



## 23.2 Rotor and accessories



On the EBA 200 S, the rotor may only be installed and removed by Customer Service for safety reasons.

### 23.2.1 Cleaning and care

- To avoid corrosion and changes to the materials, the rotor and accessories have to be cleaned regularly with soap or a mild cleaning agent and a moist cloth. Cleaning is recommended at least once a week. Contaminants must be removed immediately.
- Ingredients of suitable detergents:  
soap, anionic tensides, non-ionic tensides.
- After using detergents, remove detergent residue by rinsing with water (only outside of the centrifuge) or wipe off with a damp cloth.
- The rotor and accessories have to be dried immediately after cleaning.
- Check the rotor and accessories weekly for wear and corrosion damage.



The rotor and accessories must no longer be used if they show signs of wear or corrosion.

- Check the firm seating of the rotor on a weekly basis.

### 23.2.2 Disinfection

- If infectious material should get on the rotor or accessories, they must be appropriately disinfected.
- Ingredients of suitable disinfectants:  
ethanol, n-propanol, ethyl hexanol, anionic tensides, corrosion inhibitors.
- After using disinfectants, remove disinfectant residue by rinsing with water (only outside of the centrifuge) or wipe off with a damp cloth.
- The rotor and accessories must be dried directly after disinfection.

### 23.2.3 Removal of radioactive contaminants

- The agent must be specifically labelled as being an agent for the removal of radioactive contaminants.
- Ingredients of suitable agents for removing radioactive contaminants:  
anionic tensides, non-ionic tensides, polyhydrated ethanol.
- After removing the radioactive contaminants, remove agent residue by rinsing with water (only outside of the centrifuge) or wipe off with a damp cloth.
- The rotor and accessories must be dried directly after removing the radioactive contaminants.

### 23.2.4 Rotors and accessories with limited service lives (for EBA 200 only)

The period of use of the rotor is limited to 50000 running cycles (centrifugation runs). The maximum permissible number of run cycles can be seen on the rotor.



For safety reasons, the rotor may no longer be used when the maximum allowed number of running cycles (marked on it) has been reached.

The device is equipped with a cycle counter which counts the running cycles (centrifugation runs). For a description, see the "Cycle counter" chapter.

### 23.3 Autoclaving



On the EBA 200 S, the rotor must not be autoclaved.



On the EBA 200, the rotor may be autoclaved at 121°C / 250°F (20 min).  
After 10 autoclaving cycles, the rotor must be exchanged for safety reasons.

No statement can be made about the degree of sterility.



Autoclaving accelerates the ageing process of plastics. In addition, it can cause discolourations in plastics.

### 23.4 Centrifuge containers

- With leakiness or after the breakage of centrifuging containers broken container parts and leaked centrifugation material are to be completely removed.
- The rubber inserts as well as the plastic sleeves of the rotors are to be replaced after a glass breakage.



Remaining glass splinters cause further glass breakage!

- If this concerns infectious material, a disinfection process is to be executed immediately.

## 24 Faults



If the fault cannot be eliminated with the help of the fault table, please inform Customer Service.

Please specify the type of centrifuge and the serial number. Both numbers can be found on the name plate of the centrifuge.



Perform a MAINS RESET:

- Switch off the mains switch (switch position "0").
- Wait at least 10 seconds and then switch on the mains switch again (switch position "I").

Message / fault		Cause	Remedy
No display		No voltage Mains input fuses defective.	<ul style="list-style-type: none"> <li>- Check distribution voltage.</li> <li>- Check mains power input fuse, refer to Chapter "Change mains input fuse".</li> <li>- Mains switch ON.</li> </ul>
TACHO ERROR	1, 2	Failure of speed impulses during operation.	<ul style="list-style-type: none"> <li>- Perform a MAINS RESET when the rotor has been stationary.</li> </ul>
LID ERROR	4.1 – 4.127	Error in lid locking or lid closure.	
OVER SPEED	5	Rotation too fast	
MAINS INTER	11	Power failure during the centrifugation run. (The centrifugation run was not finished.)	<ul style="list-style-type: none"> <li>- Open the lid after the rotor is at a standstill.</li> <li>- Push  button.</li> <li>- Repeat the centrifugation run if necessary.</li> </ul>
VERSION ERROR	12	Incorrect centrifuge model recognized. Error / defect electronics	<ul style="list-style-type: none"> <li>- Perform a MAINS RESET when the rotor has been stationary.</li> </ul>
UNDER SPEED	13	Rotation too slow	
CTRL ERROR	22 – 25.4	Error / defect electronics	
CRC ERROR	27.1		
COM ERROR	31 – 36		
FC ERROR	60, 61.1 – 61.21, 61.64 – 61.142, 151		
FC ERROR	61.23		Speed measurement error
TACHO ERR	61.22	<ul style="list-style-type: none"> <li>- The device may not be switched off as long as the rotation display  is lit up and rotating. Wait until the symbol  (lid locked) is displayed (after approx. 120 seconds). Afterwards, carry out a MAINS RESET.</li> </ul>	
IMBALANCE		The rotor is unevenly loaded.	<ul style="list-style-type: none"> <li>- Open the lid after the rotor is at a standstill.</li> <li>- Check the loading of the rotor, see chapter "Loading the rotor".</li> <li>- Repeat the centrifugation run.</li> </ul>
FC ERROR	61.153	Error / defect electronics	<ul style="list-style-type: none"> <li>- Perform a MAINS RESET.</li> <li>- Check the loading of the rotor, see chapter "Loading the rotor".</li> <li>- Repeat the centrifugation run.</li> </ul>
VERS. ERR	61.154	Invalid machine version	<ul style="list-style-type: none"> <li>- Perform a MAINS RESET.</li> </ul>

## 25 Change mains input fuses



Switch off the mains switch and separate the device from the mains!

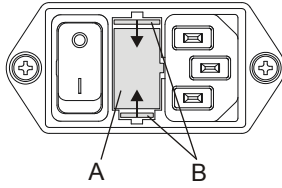

The fuse holder (A) with the mains input fuses is located next to the mains switch.

- Remove the connecting cable from the machine plug socket.
- Press the snap-fit (B) against the fuse holder (A) and remove.
- Exchange defective mains input fuses.



Only use fuses with the rating defined for the type. See the following table.

- Reinsert the fuse holder until the snap-fit clicks shut.
- Reconnect the device to the mains supply.

Model	Type	Fuse	Order no.
EBA 200	1800	T 1,6 AH/250V	E891
EBA 200	1800-01	T 3,15 AH/250V	E997
EBA 200 S	1802	T 3,15 AH/250V	E997
EBA 200 S	1802-01	T 6,3 AH/250V	2266

## 26 Returning Devices



Before returning the device, a transport securing device has to be installed.

If the device or its accessories are returned to Andreas Hettich GmbH & Co. KG, in order to provide protection for people, the environment and materials, it has to be decontaminated and cleaned before being shipped.

We reserve the right to refuse contaminated devices or accessories.

Costs incurred for cleaning and disinfection are to be charged to the customer.

We ask for your understanding in this matter.

## 27 Disposal

Before disposal, the device must be decontaminated and cleaned to protect people, the environment and property.

When you are disposing of the device, the respective statutory rules must be observed.

Pursuant to guideline 2002/96/EC (WEEE), all devices supplied after August 13, 2005 may not be disposed as part of domestic waste. The device belongs to group 8 (medical devices) and is categorized in the business-to-business field.











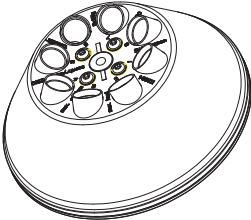











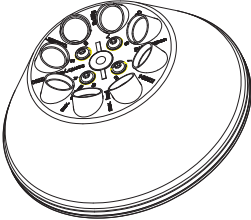

The icon of the crossed-out trash can shows that the device may not be disposed as part of domestic waste.

The waste disposal guidelines of the individual EC countries might vary. If necessary, contact your supplier.

28 Anhang / Appendix









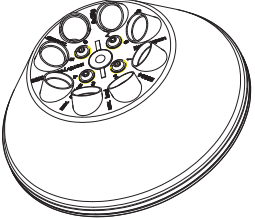

28.1 Rotoren und Zubehör / Rotors and accessories

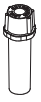

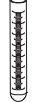

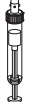



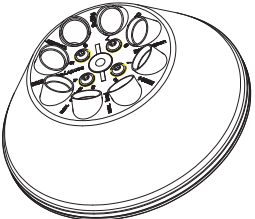

EBA 200: E3694 EBA 200 S: E1624									
<b>Winkelrotor 8-fach / Angle rotor 8-times</b>  33° EBA 200: 6000 RPM EBA 200S: 8000 RPM		0509							
			 2)						
Kapazität / capacity	ml	12	15	4,9	4,5 - 5	7,5 - 8,5	9 - 10	4 - 7	8
Maße / dimensions	Ø x L mm	17 x 102	17 x 120	13 x 90	11 x 92	15 x 92	16 x 92	13 x 100	16 x 125
Anzahl p. Rotor / number p. rotor		8	4	8	8	8	8	8	4
Drehzahl / speed	RPM	6000 / 8000							
RZB / RCF		3461 / 6153							
Radius / radius	mm	86							
 (97%)	sec	17 / 12							
 f	sec	37 / 17							
Probenerwärmung/Sample temp. rise	K <sup>1)</sup>	5 / 12							

EBA 200: E3694 EBA 200 S: E1624			1054-A + 0701	1054-A					
<b>Winkelrotor 8-fach / Angle rotor 8-times</b>  33° EBA 200: 6000 RPM EBA 200S: 8000 RPM									
									
Kapazität / capacity	ml	10	4	5	5	6	1,1 - 1,4	2,7 - 3	2,6 - 3,4
Maße / dimensions	Ø x L mm	15 x 102	12 x 60	13 x 75	12 x 75	12 x 82	8 x 66	11 x 66	13 x 65
Anzahl p. Rotor / number p. rotor		8	8	8	8	8	8	8	8
Drehzahl / speed	RPM	6000 / 8000							
RZB / RCF		3461 / 6153	2656 / 4722	2697 / 4794					
Radius / radius	mm	86	66	67					
 (97%)	sec	17 / 12							
 f	sec	37 / 17							
Probenerwärmung/Sample temp. rise	K <sup>1)</sup>	5 / 12							

1) Probenerwärmung bei maximaler Drehzahl und 1 Stunde Laufzeit  
 2) Nur jeden zweiten Platz des Rotors beladen

1) Sample temp. rise during maximum speed and 1 hour running time  
 2) Load only each second position of the rotor

EBA 200: E3694 EBA 200 S: E1624									
<b>Winkelrotor 8-fach / Angle rotor 8-times</b>  33° EBA 200: 6000 RPM EBA 200S: 8000 RPM	1063								
					6305	SK 1/89	SK 19/85-4		
				0518					
	      								
Kapazität / capacity ml	0,5	8,5 - 10	15	4	0,8	4 - 5,5	4 - 7		
Maße / dimensions Ø x L mm	10,7 x 36	16 x 100	17 x 100	10 x 88	8 x 45	15 x 75	16 x 75		
Anzahl p. Rotor / number p. rotor	8	8	8	8	8	8	8		
Drehzahl / speed RPM	6000 / 8000								
RZB / RCF	2214 / 3935	3461 / 6153	3461 / 6153	2817 / 5009	2173 / 3864	2978 / 5295	3059 / 5438		
Radius / radius mm	55	86	86	70	54	74	76		
 (97%) sec	17 / 12								
 f sec	37 / 17								
Probenerwärmung/Sample temp. rise K <sup>1)</sup>	5 / 12								

EBA 200: E3694 EBA 200 S: E1624									
<b>Winkelrotor 8-fach / Angle rotor 8-times</b>  33° EBA 200: 6000 RPM EBA 200S: 8000 RPM	1059								
									
			0501		0553				
	      								
Kapazität / capacity ml	1,6 - 5	1,1 - 1,4	6	2,6 x 3,4	5	2,7 - 3	5		
Maße / dimensions Ø x L mm	13 x 75	8 x 66	12 x 82	13 x 65	12 x 75	11 x 66	13 x 75		
Anzahl p. Rotor / number p. rotor	8	8	8	8	8	8	8		
Drehzahl / speed RPM	6000 / 8000								
RZB / RCF	2777 / 4937								
Radius / radius mm	69								
 (97%) sec	17 / 12								
 f sec	37 / 17								
Probenerwärmung/Sample temp. rise K <sup>1)</sup>	5 / 12								

1) Probenerwärmung bei maximaler Drehzahl und 1 Stunde Laufzeit

1) Sample temp. rise during maximum speed and 1 hour running time

#### **GERMANY**

EICKEMEYER  
Eltastraße 8  
78532 Tuttlingen  
Germany  
T +49 7461 96 580 0  
F +49 7461 96 580 90  
E [info@eickemeyer.de](mailto:info@eickemeyer.de)  
[www.eickemeyer.de](http://www.eickemeyer.de)

#### **UNITED KINGDOM**

EICKEMEYER  
47 St. Margarets Grove  
Twickenham, Greater London  
TW1 1 JF  
United Kingdom  
T +44 20 8891 2007  
F +44 20 8891 2686  
E [info@eickemeyer.co.uk](mailto:info@eickemeyer.co.uk)  
[www.eickemeyer.co.uk](http://www.eickemeyer.co.uk)

#### **NETHERLANDS**

EICKEMEYER  
Bedrijventerrein  
Pavijen-West Bellweg 44  
4104 BJ Culemborg  
Netherlands  
T +31 345 58 9400  
F +31 345 58 9401  
E [info@eickemeyer.nl](mailto:info@eickemeyer.nl)  
[www.eickemeyer.nl](http://www.eickemeyer.nl)

#### **CANADA**

EICKEMEYER  
250 Briarhill Dr.  
Stratford  
Ont. Canada  
N5A 7S2  
T +1 519 273 5558  
F +1 519 271 7114  
E [info@eickemeyer.com](mailto:info@eickemeyer.com)  
[www.eickemeyerveterinary.com](http://www.eickemeyerveterinary.com)

#### **DENMARK**

EICKEMEYER  
Lysbjergvej 6, Hammelev  
6500 Vojens  
Denmark  
T +45 7020 5019  
F +45 7353 5019  
E [info@eickemeyer.dk](mailto:info@eickemeyer.dk)  
[www.eickemeyer.dk](http://www.eickemeyer.dk)

#### **ITALY**

EICKEMEYER  
Via G. Matteotti 16  
64029 Silvi Marina (TE)  
Italy  
T +39 085 935 4078  
F +39 085 935 9471  
E [info@eickemeyer.it](mailto:info@eickemeyer.it)  
[www.eickemeyer.it](http://www.eickemeyer.it)

#### **SWITZERLAND**

EICKEMEYER  
Sandgrube 29  
9050 Appenzell  
Switzerland  
T +41 71 788 23 13  
F +41 71 788 23 14  
E [info@eickemeyer.ch](mailto:info@eickemeyer.ch)  
[www.eickemeyer.ch](http://www.eickemeyer.ch)